



Safari 2.2 VTT
DICOR

Owner's Manual

TATA MOTORS

VEHICLE IDENTIFICATION AND RECORD :

OWNER'S NAME : _____

ADDRESS : _____

SELLING DEALER CODE : _____

DATE OF DELIVERY : _____

DATE OF REGISTRATION : _____

REGISTRATION NO. : _____

CHASSIS NO. : _____

ENGINE NO. : _____

GEAR BOX NO. : _____

TRANSFERCASE NO. : _____

REAR AXLE NO. : _____

FRONT AXLE NO. : _____

BATTERY MAKE : _____

BATTERY SR. NO. : _____

BATTERY CODE : _____

THE WARRANTY ON THIS CAR IS VALID ONLY IF THE DETAILS ARE FILLED, SIGNED AND STAMPED BY THE SELLING DEALER

**DEALER'S SIGNATURE
AND STAMP**



Following items are provided with your TATA Safari :

1. Owner's Manual & Service Book
2. Battery Warranty Card
3. First Aid Kit
4. Advance Warning Triangle
5. Jack and Handle
6. Spare Headlamp bulbs - 2 Nos.
7. Spare Fuses - (Provided in fuse box)
8. Tool Kit
 - a. Wheel Spanner
 - b. Screw Driver
 - c. Ring Spanner (8-9)
 - d. Socket Handle
(Part No. 2654 5890 35 24)
9. Manufacturer's manual for
 - a. Music System (if fitted)
 - b. Immobiliser (if fitted)

Tata Safari (2.2 VTT DICOR)

4x2 & 4x4

Owner's Manual

This owner's manual should be considered as a permanent part of the car and must remain with the vehicle.

TATA MOTORS
PASSENGER VEHICLE BUSINESS UNIT
• MUMBAI • PUNE •

C O N T E N T S



1. Foreword	5
2. 24x7 On Road Assistance	5a
3. Important information for owners	6
4. Environmental Protection	8
5. Warranty	10
6. Location of Chassis & Aggregate Identification Numbers	12
7. Getting into the vehicle	13
8. Your Safety	15
9. Driving Controls	27
10. Indicators and Instruments	41
11. Comfort and Convenience	51
12. Prior to driving	69
13. Driving	75
14. Fuel, Coolants & Lubricants	91
15. Vehicle Specifications	97
16. Maintenance	103
17. Preliminary Trouble Shooting	136
18. Special Instructions	144
19. Service Schedule	145
20. Alphabetical Index	155
21. Service Set up Addresses	A-1

Dear Customer,

Thank you for selecting Tata Safari - the vehicle of your choice

We welcome you to the world of advanced automotive engineering in a form especially suited to your operating conditions.

This book gives you all the information necessary for making your ownership of this vehicle a thoroughly satisfying experience.

To assist you in maintaining your vehicle as per recommended schedule, we have a widespread network of dealers and service centres. The list is included in this book for your convenience.

Should you need any special assistance, please call on our Regional / Zonal level offices which are also listed in this book.

Please note that by adhering to the correct operating procedures and by availing the scheduled maintenance services at our authorised service centres, you can obtain the maximum performance from your vehicle.

We request you to go through the book and derive many miles of motoring pleasure.

TATA MOTORS LIMITED

We provide safe, high quality, high performance vehicles. In order to maintain the level of performance and reliability in the vehicle, it is important that any accessory that is fitted or modification that is carried out should be done with extreme caution and in consultation with our authorised dealer. Any improper installation can hamper the safety and performance of the vehicle besides depriving you of your warranty benefits.

Use of genuine parts, designed and manufactured to our exacting standards, are the best way to maintain your vehicle in peak operating condition. Please do not use substitutes. They always prove costlier in the long run.

Failure to use genuine parts can invalidate any future warranty claims.

The information and specifications given in this book are valid as on the date of printing. Tata Motors Limited reserves the right to make changes in design and specifications and/or to make additions to or improvements in this product without obligation to install them on products previously sold.

Dear Customer,

It is our responsibility and our endeavour to ensure that you have our complete service backup if ever, wherever and whenever you need the same. When you have a road network that spans 33.80 kms, the probability of a breakdown happening within hailing distance of a **TATA MOTORS** Authorized Workshop is very low.

It is Precisely for this reason, we have tied up with MyTVS, who will provide breakdown assistance including towing to the nearest **TATA MOTORS** Authorized Workshop through their Authorized Service Providers (ASP)

The **24X7 On Road Assistance** Program shall be automatically available to your vehicle for the duration of Warranty period. The program shall also be available for Extended Warranty period if you avail the same at the time of buying of your vehicle.



Response Time ** for the On Road Assistance Program

Within City Limits	60 minutes
On State or National Highways	90 minutes
Ghat Roads and other places	120 minutes +/-

(The response time will depend on the location, terrain, traffic density and the time of the day.)

Standard procedure when calling for On Road Assistance in case of a breakdown:

- Dial the toll free help line number – **1 800 209 7979**
- Identify your vehicle with the Vehicle chassis number that is available in the Owners Service manual or on the Helpline sticker on the dashboard, near the steering wheel.
- Explain your exact location with landmarks and tell us about the problem you face with the vehicle.
- Park your vehicle on the edge of the road, open the bonnet and put on the hazard warning signal.
- Place the caution sign supplied with the vehicle approx. 3 m from the vehicle in the direction of on coming traffic.

Coverage under the 24 X 7 On road Assistance Program

- I. The **24x7 On Road Assistance** Program Service covers the following services on your vehicle during warranty period.
- Wheel change through spare wheel.
 - Arrangement of fuel. (Fuel cost will be chargeable at actual cost)
 - Re-opening the vehicle in cases of key lock out.
 - Rectification of electrical problems related to battery, fuses etc.
 - On spot repairs for complaints repairable at site. ^
 - Car to car towing or winching & towing for non accident cases up to a maximum of 15 kms to the nearest Tata Motors authorized workshop. Towing charges at actual cost beyond the same to be paid to the ASP in cash. (Any ferry or toll charges levied in relation to the vehicle being towed to be paid by the customers in actuals in cash).

- II. The **24x7 On Road Assistance** Program coverage as indicated above during the extended warranty period of your vehicle is up to a maximum of 3 events for 18/12 months extended warranty period & 4 events for 30/24 months extended warranty period.

- III. The **24x7 On Road Assistance** Program as indicated above covers Tata Motors Assured vehicles during the extended warranty period up to a maximum of 3 events.

Exclusions

24x7 On Road Assistance Program does not apply to

- Cost of parts consumables and labour for such repairs not covered under warranty*. These charges are to be settled with ASP in cash.
- Toll or ferry charges paid by ASP in reaching to the breakdown site to be settled with ASP in actuals in cash.
- Cases involving accident, fire, theft, vandalism, riots, lightening, earthquake, windstorm, hail, tsunami, unusual weather conditions, other acts of God, flood, etc.
- Vehicles that are unattended, un-registered, impounded or abandoned.

- Breakdown/defects caused by misuse, abuse, negligence, alterations or modifications made to the vehicle.
- Lack of maintenance as per the maintenance schedule as detailed in the owner's manual.
- Cases involving racing, rallies, vehicle testing or practice for such events.

Disclaimer

- The service is not available in the states of Arunachal Pradesh, Assam (Except Guwahati City), Meghalaya, Manipur, Mizoram, Nagaland, Sikkim, Tripura, J&K and in Union Territories of Andaman & Nicobar Islands and Lakshwadeep.
- **The reach time is indicative & the actual reach time will be conveyed by the call centre at the time of breakdown call.
- The reach time can vary depending on the traffic density & time of the day.
- The reach time indicated does not account for delays due to but not limited to acts of God, laws, rules & regulations for time being in force, orders of statutory or Govt. authorities, industrial disputes, inclement

weather, heavy down pour, floods, storms, natural calamities, road blocks due to accidents, general strife and law & order conditions viz. fire, arson, riots, strikes, terrorist attacks, war etc.

- ^ On spot repairs at breakdown site shall depend on nature of complaints & will be as per the discretion of the ASP.
- *The decision for free of charge repairs will be as per the warranty policy & procedures of **TATA MOTORS LTD.** and as per the interpretation of the same by ASP. You will be duly informed by the ASP & call centre for the change applicable if any.
- All charges wherever applicable need to be settled directly with the ASP.

EXCLUSION OF LIABILITIES :

- It is understood that **TATA MOTORS** shall be under no liability whatsoever in respect of any loss or damage arising directly or indirectly out of any delay in or non delivery of, defect/deficiency in service/parts provided by ASP.
 - In case vehicle cannot be repaired on-site, customers are advised to use the towing facility for taking their vehicle to the nearest **TATA** authorized workshop only. In no condition will the vehicle be towed to any unauthorized workshop. **TATA MOTORS** will not be responsible for any repairs carried out in such unauthorized workshop.
 - Customer are advised to take acknowledgment from the ASP for the list of accessories/extra fittings and other belongings in the vehicle as well as the current condition related to dents/scratches breakages of parts/fitments of the vehicle at the time of ASP taking possession of the vehicle & to verify these items when delivery is taken back by them, Claim for loss of or damage to items, if any should be taken up with ASP directly. **TATA MOTORS** shall not be responsible for any such claims, damages/loss or any deficiency of service of the ASP.
- Vehicles will be handled, repaired & towed as per the customer's risk & **TATA MOTORS** shall not be liable for any damages / claims as a result of the same.
 - Services entitled to the customers can be refused or cancelled on account of abusive behaviour, fraudulent representation, malicious intent and refusal to pay the charges for any charges related services and spare parts during service or on previous occasion on part of the customer.
 - On site repairs may be temporary in nature. The completion of repairs does not certify the road worthiness of the vehicle. The customer is advised to ensure temporary repairs carried out onsite is followed by permanent repairs at **TATA MOTORS** Authorized Workshop at the earliest.
 - Terms and conditions and service coverage, exclusions etc. are subject to change without notice.

Safety and vehicle damage warnings

In this manual, you will see CAUTION, NOTICE and WARNING. These are used in the following ways.

CAUTION

This is a warning against something which may cause injury to people if the warning is ignored. You are informed what you must or must not do in order to avoid or reduce the risk to yourself and other people.

NOTICE

This is a warning against something which may cause damage to the vehicle or its equipment if the warning is ignored. You are informed what you must or must not do in order to avoid or reduce the risk of damage to your vehicle and its equipment.

WARNING

Indicates a strong possibility of severe personal injury or death if the instructions are not followed.

Safety symbol

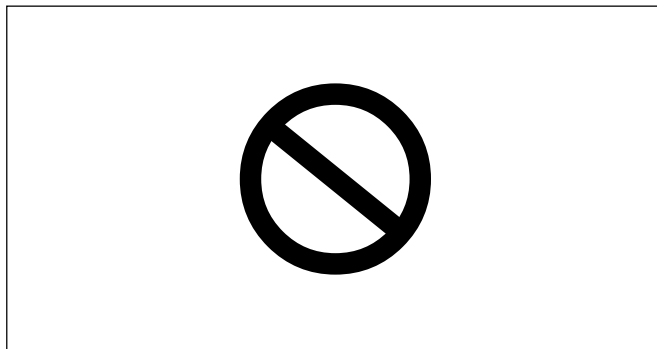

In this manual, you will also see a circle with a slash. This means "Do not", "Do not do this", or "Do not let this happen".

ENVIRONMENTAL PROTECTION

TATA MOTORS LTD. is committed to produce the vehicles using environmentally sustainable technology. A number of features have been incorporated in Tata Motors passenger vehicles which have been designed to ensure environmental compatibility throughout the life cycle of the vehicle. We would like to inform you that your vehicle meets emission norms and this is being regularly validated at the manufacturing stages.

As a user you too can protect the environment by operating your vehicle in a proactive manner. A lot depends on your driving style and the way you maintain your car. We have given few tips below for your guidance.

DRIVING

- Avoid frequent and violent accelerations.
- Do not carry any unnecessary weight on the vehicle as it overloads the engine. Avoid using devices requiring high power consumption during slow city traffic condition.
- Monitor the vehicle's fuel consumption regularly and if showing rising trend get the vehicle immediately attended at the Company's Authorised Service Outlets.

- Switch off the engine during long stops at traffic jams or signals. If you need to keep the engine running, avoid unnecessary revving it up or stopping and starting.
- It is not necessary to rev up the engine before turning it off as it unnecessarily burns the fuel.
- Shift to higher gears as soon as it is possible. Use each gear upto 2/3rd of it's maximum engine speed. A chart indicating gear shifting speeds is given in this book.

MAINTENANCE

- Ensure that recommended maintenance is carried out on the vehicle regularly at the Authorised Service Outlets.
- As soon as you see any leakages of oil or fuel in the vehicle we recommend to get it attended immediately.
- Use only recommended grades and quantity of lubricants and clean/uncontaminated and correct fuels.
- Get your vehicle checked for emission periodically by authorised dealer

ENVIRONMENTAL PROTECTION

- Ensure that fuel filter, oil filter and breather are checked periodically and replaced, if required, as recommended by Tata Motors.
- Do not pour the used oils or coolants into the sewage drains, garden soil or open streams. Dispose the used filters and batteries in compliance with the current legislation.
- Do not allow unauthorised person to tamper with engine settings or to carry modifications on the vehicle.
- Never allow the vehicle to run out of fuel.
- Parts like brake liners, clutch disc should be vacuum cleaned. Do not use the compressed air for cleaning these parts which may spread the dust in the atmosphere.
- **While carrying out the servicing or repairs of your vehicle you should pay keen attention to some of the important engine aggregates and wiring harness which greatly affect emission. These components are :-**
 1. **Fuel injection equipments : pump, rail, Injectors, Nozzles and high pressure pipes.**

2. **Air Intake & Exhaust system especially for leakages.**
3. **Cylinder head for valve leakage.**
4. **All filters such as air, oil & fuel filters (check periodically).**
5. **Turbocharger & Vacuum Modulator OR it's vacuum hoses.**
6. **EGR System & components.**
7. **Electrical connections**
8. **'Service' lamp contineously glows, please take the vehicle to Service Station.**
9. **Catalytic Convertor**
10. **EMS wiring harness i.e. electrical connections to all sensors and actuators.**

This owner's manual contains further information on driving precautions and maintenance care leading to environment protection. Please familiarise yourself with these aspects before driving.

We **WARRANT** each **TATA Safari 4X2 and 4X4** vehicles & parts thereof manufactured by us to be free from defect in material and workmanship, subject to the following terms & conditions :

1. This warranty shall be for **24 months OR 75,000 kms, whichever is earlier from the date of sale of the vehicle.**
2. Our obligation under this warranty shall be limited to repairing or replacing, free of charge, such parts of the vehicle which, in our opinion, are defective, on the vehicle being brought to us or to our dealers within the warranty period. The parts so repaired or replaced shall also be warranted for quality and workmanship but such warranty shall be co-terminus with this original warranty.
3. Any part which is found to be defective and is replaced by us under the warranty shall be our property.
4. As for such parts as tyres, batteries, transfer case, rubber parts, electrical equipment and fuel injection equipment, power steering equipment, A.C. equipment not manufactured by us but supplied by other parties, this warranty shall not apply, but buyers of the vehicle shall be entitled to, so far as permissible by law, all such rights as we may have against such parties under their warranties in respect of such parts. Our Dealers/TASC's will assist the purchaser in taking up the complaint with the respective manufacturers and their decision on the warranty will be final.
5. This warranty shall not apply if the vehicle or any part thereof is repaired or altered otherwise than in accordance with our standard repair procedure, or by any person other than our sales or service establishments, our authorised dealers or service centres or service points in any way so as, in our judgement which shall be final and binding, to effect its reliability, nor shall it apply if, in our opinion which shall be final and binding the vehicle is subjected to misuse, negligence, improper or inadequate maintenance or accident or loading in excess of such carrying capacity as certified by us, or such services as prescribed in our Owner's Manual and Service Book are not carried out by the buyer through our sales or service establishments, our authorised dealers or service centres or service points.
6. This warranty shall not cover normal wear and tear or any inherent normal deterioration of the vehicle or any of its parts arising from the actual use of the vehicle or any damage due to negligent or improper operation or storage of the vehicle. This warranty shall not apply to normal maintenance services viz. oils & fluid changes, head lamps focussing, fastener retightening, wheel balancing, tyre

rotation, adjustment of valve clearance, fuel timing, ignition timing and consumables like bulbs, fuel filters and oil filters etc. This warranty shall not apply to any damage or deterioration caused by environmental pollution or bird droppings. This warranty shall not apply to V-belts, hoses and gas leaks in case of air conditioned vehicle. Slight irregularities not recognised as affecting the function or quality of the vehicle or parts such as slight noise or vibration and defects appearing only under particular or irregular operations or items considered characteristic of the vehicle.

7. This warranty shall be null and void if the vehicle is subjected to abnormal use such as rallying, racing or participation in any other competitive sports. This warranty shall not apply to any repairs or replacement as a result of accident or collision.

8. This warranty is expressly in lieu of all warranties, whether by law or otherwise, expressed or implied, and all other obligations or liabilities on our part and we neither assume nor authorise any person to assume on our behalf, any other liability arising from the sale of the vehicle or any agreement in relation thereto.

9. The buyer shall have no other rights except those set out above and have, particular, no right to repudiate the sale, or any agreement or to claim any reduction in the purchase price of the vehicle, or to demand any damages or compensation for losses, incidental or indirect, or inconvenience or consequential damages, loss of vehicle, or loss of time, otherwise, incurred or accrued.

10. Any claim arising from this warranty shall be recognised only

if it is notified in writing to us or to our concerned dealer without any delay soon after such defect as covered and ascertained under this warranty.

11. This warranty shall stand terminated if the vehicle is transferred or otherwise alienated by the buyer without our prior written consent.

12. We reserve our rights to make any change or modification in the design of the vehicle or its parts or to introduce any improvement therein or to incorporate in the vehicle any additional part or accessory at any time without incurring any obligation to incorporate the same in the vehicles previously sold.

TATA MOTORS

LOCATION OF CHASSIS AND AGGREGATE IDENTIFICATION NUMBERS

LOCATION OF AGGREGATE IDENTIFICATION NUMBERS

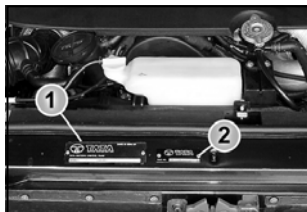

1. CHASSIS NUMBER PLATE
2. CAB NUMBER PLATE



CHASSIS NUMBER ON FRAME



ENGINE NUMBER



ENGINE NUMBER

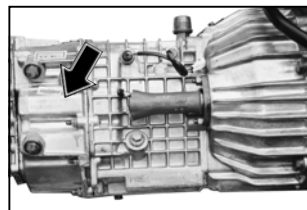

GEAR BOX NUMBER

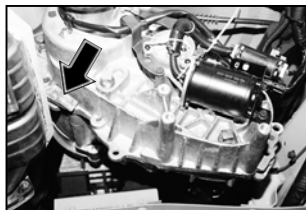

TRANSFERCASE NUMBER



REAR AXLE NUMBER



FRONT AXLE NUMBER

Central Locking System (Operated by key) :

Your Tata Safari has a single key for operating ignition, steering lock, glove box and doors.

All the four doors and rear door have electrically operated central locking system.

With central locking system all the doors can be locked or unlocked from driver side with the key.

CAUTION

You can also lock the door from outside by closing the door with knob pushed in.

While following the procedure, ensure that key is not left inside the vehicle.

All the four doors can also be locked or unlocked from inside by pressing or pulling the knob near door opening lever.



Door Lock - Outside

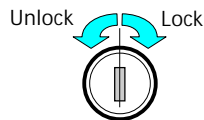

1. Door Opening Lever
2. Locking / Unlocking Knob

Door Lock - Inside

This section gives you important information about safety features of the vehicle meant for occupant protection. It provides information on the use of seat, seat belts, headrest and seat adjustments.

In addition to seat and seat belts, there are number of other features as listed alongside which are built in the design of the vehicle so as to take care of your safety.

- **Seat belt system**
- **Wearing seat belt**
- **Headrest**
- **Door locks**
- **Child lock**
- **Audio warning**
- **Collapsible steering column**
- **Air Bag (if fitted)**
- **Anti-Lock Brake System (if fitted)**

The safety of the occupants is of prime importance to us.

Your 'TATA SAFARI' has many features that work together to protect the occupants.

Seat Belts

TATA SAFARI is equipped with seat belts as a part of occupant restraint system.

Why Seat Belts

Wearing seat belts properly can protect you from being thrown against the inside of the vehicle, against other occupants or out of the vehicle, in case of an accident or sudden braking. It will reduce the chances of severe injury.

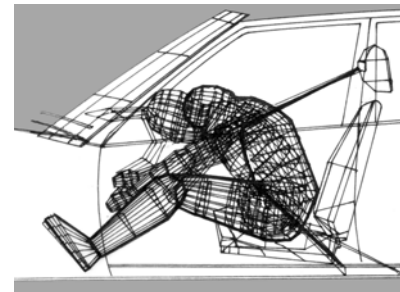

System Components and Wearing Seat Belt

Your 'TATA SAFARI' has three point inertia reel type front and rear seat belts in the out board positions and a lap belt for middle passenger on rear seat. In normal driving the belt lets you move freely in your seat. In case of an accident or sudden braking inertia reel automatically tightens the belt to help restrain your body.

The anchor end of the shoulder belt is adjustable to suit the height of the passenger wearing it. The lap belt has one manually adjusted belt that fits across the hip bone. It is similar to safety belt used in aeroplanes.

Make sure that your seat is adjusted to a good driving position and the back of the seat is upright.

1. Pull the tongue across your body and insert it into the buckle.
2. Check and ensure that the belt is not twisted.
3. Position the lap portion of the belt as low as possible across your hip bone.
4. Pull up the shoulder part of the belt to remove the slack. Make sure that the belt goes over your collar bones and across chest.
5. To unlatch the belt, press the red button on the buckle. Guide the belt to the pillar as it retracts.

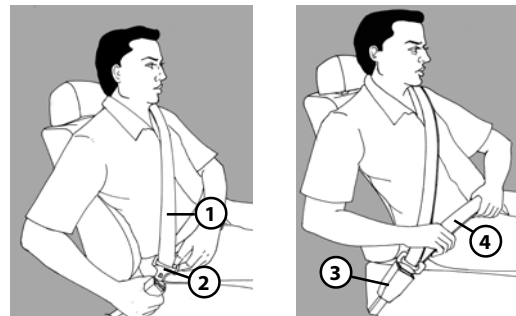

1. Seat Belt 2. Tongue 3. Lock Buckle 4. Lap Belt

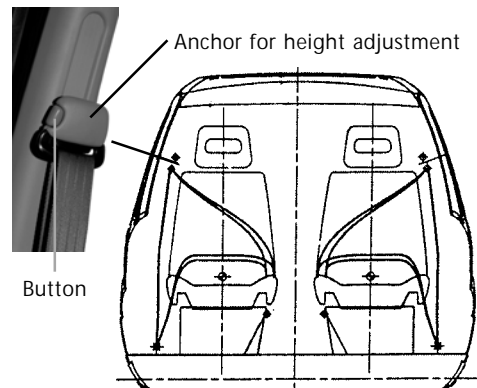

Front Seat Belt Arrangement

6. Each belt should be used by one occupant only. The belt must not be put round a child, seated on passengers lap.
7. When the belt has been in use in a serious accident or shows signs of severe fraying or of having been cut, replace with an approved belt kit.
8. The belt must not be altered or modified during use.
9. The belts are meant (intended) for adult occupants only.
10. The belts if required should be replaced, by Authorised personnel only.
11. The belt should not be disassembled. If required, authorised personnel only should carry out disassembly and assembly.

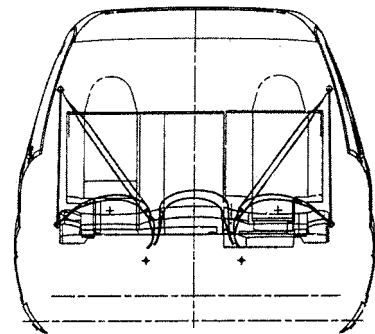

Rear Seat Belt Arrangement

Adjustable Headrest

Headrest can help to protect you from whiplash and other injuries. For best protection adjust the top of the headrest as shown in the figure.

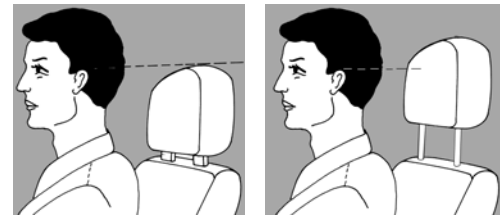

Poor Adjustment

Good Adjustment

Seat-belt precautions for Baby, small child, Pregnant woman and injured person :

TATA MOTORS strongly urges that the driver and passengers in the vehicle be properly restrained at all times with the seat-belts. Failure to do so could increase the chance of injury and / or the severity of injury in accidents.

Baby or Small Child :

Use child restraint system appropriate for the child until the child becomes large enough to properly wear the vehicle's seat-belts.

If a child is too large for a child restraint system, the child should sit in the seat and must be restrained using the vehicle's seat-belt.

Also use the seat-belt while the child is in the rear seat. According to accident statistics, the child is safer when properly restrained in the rear seat than in the front seat.

Child restraint systems are available. **TATA MOTORS** recommend the use of a type which fits to your vehicle. Before installation, always read the manufacturer's instructions.

Pregnant Woman :

TATA MOTORS recommends the use of a seat-belt. Ask your doctor for specific recommendations. The lap belt should be worn securely and as low as possible over the hips and not to waist.

Injured person :

TATA MOTORS recommends the use of a seat-belt for injured person. Depending on the injury, first check with your doctor for specific recommendations.

Backrest Position

To get the maximum protection from the seat belts, the back of the seat should be in an upright position. If you recline the backrest, you reduce the protective capability of the seat belt.



Seat backrest reclining lever

Door Locks

Lock the vehicle doors when in motion. Doors are designed to remain closed and stay unlocked in accident. This is to facilitate outsiders to open doors and evacuate occupants in the event of an accident.

Child Lock

This is provided on both rear doors and tailgate.

Push down the lock tab before closing the door. Now the door can not be opened by the children from inside. Locked doors can be opened only by using the respective door outer handles.



Childlock

Audio Warning :

Seat Belt Reminder

(Beeper and tell-tale indicator)



When the key is in ignition position & driver's seat belt is not fastened, you get an audio warning as well as tell-tale indication in cluster, indicating seat belts are not fastened. The beeper will go off automatically after a few seconds, but the tell-tale indicator will remain on as long as seat belts is not fastened.

Door Open Warning



Prior to driving, ensure that all the doors are properly closed. If any one of the doors is partially open, the door open indicator will come on. In addition to this, in case driver side door is not properly closed an audio beep will come for few seconds, when the key is inserted.

Head Lamps 'ON' Reminder

While leaving the vehicle (key out), if the head lamps are left on and driver door is opened, you will get an audio warning to remind you to put off the head-lamps. This beeper will go off after a few seconds or immediately if the head lamps are switched off.

Collapsible Steering Column

The steering column of TATA SAFARI is of collapsible type. During normal operation it works as a solid one piece column and takes all the steering efforts effectively. In case of frontal impact, the intermediate tube connecting upper and lower part of the column will collapse. This will prevent the steering column from protruding in the driver cabin and avoid injury to the driver.

Air Bags (If Fitted)

SRS (Supplementary Restraint System)

Your vehicle is fitted with an air bag for the driver, located in the steering wheel, and a passenger air bag (if fitted) is located above the glove box compartment. Airbag(s) can be identified by the "SRS AIR BAG" label on the airbag cover.

The airbag is a supplementary restraint system and is designed to provide effective protection to the belted occupants during frontal collisions.

The air bag system is not visible until it is activated. The activation depends upon the severity and direction of frontal collisions. Airbags are not designed to activate in rollover, rear and side collisions.

Operation

Sensors in the ECU detect the frontal collision severity. The air bag(s) are designed to deploy only if the collision matches the criteria for deployment.

- The sensor switches close the circuit and the propellant rapidly burns in a container producing gases, which fill the airbag.
- The inflating airbag deploys out of the steering wheel in the front of the driver and passenger air bag (if fitted) deploys out of the dashboard in front of the passenger. This action takes place in a fraction of a second.

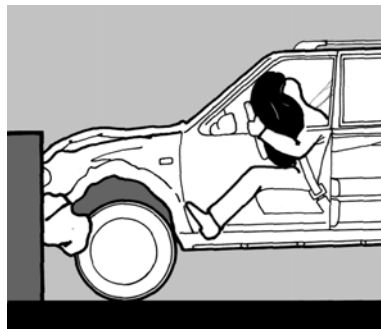
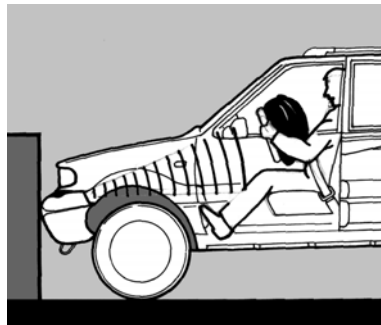

- The bag(s) deflate as the gas escapes through the vent holes in the airbag cushion.
- **Airbag(s) will only deploy with the ignition switch in “ON” position.** Immediately after air bag inflation, you may notice fairly loud noise, dust or smoke and smell of the burnt propellant. This is NORMAL.

⚠ CAUTION

- Air bag system components get hot after inflation. Do not touch after inflation.
- The smoke could cause breathing problems for people with a history of asthma or other breathing trouble. If such case occurs after deployment of air bag, get fresh air promptly.
- ***Always wear seat belts. The wearing of seat belts is required even when the air bag is fitted. Air bags do not replace the seat belts.***

The importance of wearing seat-belts :

- It will help to keep you in the proper position when the airbag inflates.
- Reduce the risk of injuries in any collision.
- Reduce the risk of being thrown out from your vehicle in a collision.

The importance of being properly seated :

In a collision, the airbag inflates extremely quickly, faster than blink of an eye and with great force.

- If you are too close to an inflating air bag, it could seriously injure you. Move your seat as far back as possible to allow room for air bag inflation. Never install any child restraint in the front seat where the passenger air bag is fitted, as serious injury or death may result from the force of the inflating front passenger air bag. The rear seat is safest place for the children.
- Never place any object in front of you while you are seated in the front seat as it may result an injury from the object when it is forced towards you by the inflating air bag. Do not cover the steering wheel or instrument panel with an object which may prevent the proper deployment of the air bag.
- Where a passenger air bag is fitted, front passenger should never sit on the edge of the seat, stand near the glove box compartment, rest feet or other parts of the body on the dash board or lean over near the glove compartment when the vehicle is moving. Passenger should also not recline the seat backwards such that the passenger goes beyond the protection range of airbags.

Air bag warning light :



The diagnostic system continually monitors the readiness of the SRS AIR BAG while the vehicle is being driven. The air bag warning light on the instrument panel will illuminate for approximately 5 seconds when the ignition is switched on. This is normal and indicates the system is performing a self check. The following components are monitored by the indicator.

- Airbag control module - ECU
- Driver airbag
- Passenger air bag (If fitted)
- Retractor Pre-tensioners.
- All related wiring.

Air bag maintenance and servicing :

If the warning light does not illuminate when ignition is switched on, or remains illuminated after the initial check period of 5 seconds or flashes during driving, indicates fault with air bag and seat belt pre-tensioner and it should be checked by an authorized **TATA MOTORS DEALER** immediately.

- The air bag warning light does not illuminate when the ignition key is turned on.
- The air bag warning light illuminates while driving.

If the air bag system is not attended to when a warning is given, it will not function properly in the event of collision, or it may deploy unexpectedly. The air bag system fitted to your vehicle does not require regular maintenance.

NOTE :

1. Any maintenance on or near the SRS components must be performed only by an authorized **TATA MOTORS** dealer. Do not permit anyone else to do service, inspection, maintenance or repair on any SRS components or wiring. Similarly, no part of the SRS system should ever be handled or disposed of by anyone except an authorized **TATA MOTORS** dealer. Improper work on the SRS system will result in inadvertent deployment of the air bag or could render the SRS system inoperative. This could also lead to personal injury.
2. Do not modify your steering wheel or any other SRS components, For example replacement of steering wheel or modifications to the steering column, front bumper, body or frame structure can adversely affect the SRS performance and lead to possible injury.
3. If your vehicle has received any front end damage, you should have the SRS system inspected by an authorized **TATA MOTORS** dealer to ensure it is in proper working order.

*The air bag will inflate only once. **The inflated air bag system will not function again and steering wheel with air bag module, steering column, seat belts and control module must be replaced immediately. If passenger airbag is fitted, air bag assembly, Air bag cover, Seat belts and dash panel must be replaced. If they are not replaced, the unrepaired area will increase the risk of injury in a collision.***

- Do not attempt to service, repair, or modify the airbag system, tampering will result in activation of the system and increase the risk of personal injury. For servicing the air bag system, see your authorized **Tata Motors** dealer.
- Do not use chemical solvents or strong detergents when cleaning the steering wheel or instrument panel to avoid contamination of the air bag system. Wiping with a damp cloth only is recommended.

Air bags and Bull bars:

TATA Motors do not guarantee the design intent performance of the supplementary restraint system in case a bull bar is fitted to the vehicle or the front structure is modified in any way.

⚠ CAUTION

- In case of vehicle ownership transfer, Tata Motors recommends the owner to inform the new owner about the presence of Supplementary Restraint System in the vehicle and also advises for reading the relevant sections in the owner's manual.
- Prior to scrapping the vehicle, owner should bring the vehicle to the authorized Tata Motors dealer for safe dismantling of supplementary restraint system.

Anti-lock braking system : (if fitted)

The Anti-lock braking system is installed to avoid wheel locking during abnormal braking conditions. Please refer ABS in '**DRIVING**' chapter for detailed information.

This section provides information about various mechanical controls and electrical displays that help you while driving.

Please read this section carefully and make yourself familiar with the functions of all the driving controls listed alongside, so that you can use them effectively while driving.

- **Driving Controls**
- **Steering lock & Ignition switch**
- **Immobiliser**
- **Parking brake**
- **Gear shift lever**
- **Combi switch**
- **Transfer case gear selector**
- **Steering wheel position adjustment**
- **Operating switches**

DRIVING CONTROLS

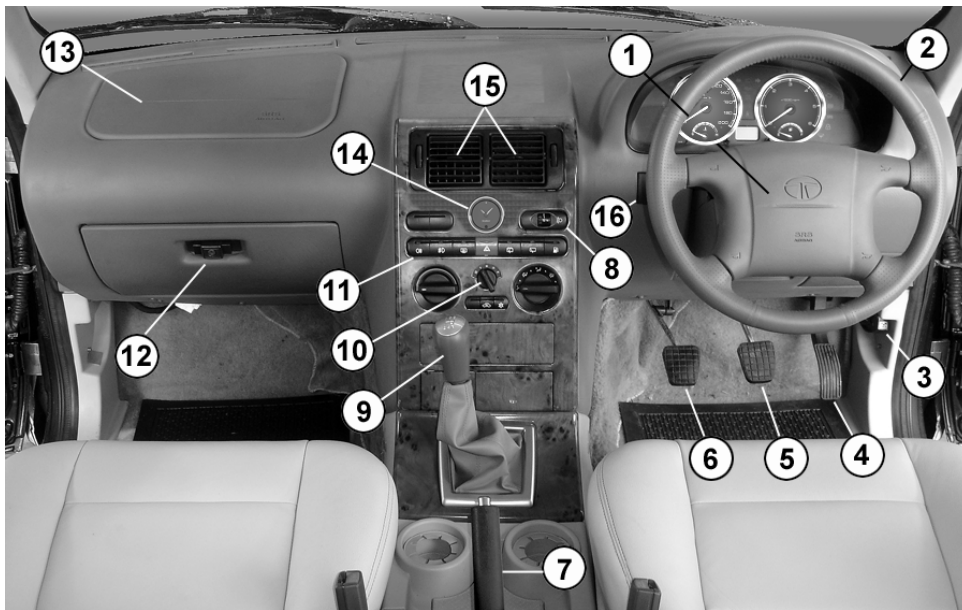

- | | | |
|--|------------------------------|-------------------------|
| 1. Air bag (SRS) for driver & Horn Pad | 2. Steering Wheel | 3. Bonnet Opening Lever |
| 4. Accelerator Pedal | 5. Brake Pedal | 6. Clutch Pedal |
| 7. Parking Brake | 8. Head Lamp Leveling Switch | 9. Gear Lever |
| 10. A.C. Control Switch | 11. Operating Switches | 12. Glove Box |
| 13. Air Bag for Co-driver | 14. Analog Clock | 15. Air Vents |
| 16. 4X4 Selector Switch | | |

Steering Lock and Ignition Switch

Key of ignition switch is common for door lock, steering lock and glove box lock.

The ignition switch is on the right side of the steering column. It has four positions. Turn the key clockwise for further functions.

- LOCK - Steering Locked
- ACC - Accessories 'ON'
- ON - All electricals 'ON'
- START - Engine crank

LOCK

You can insert or remove the key only in this position. The steering column is locked when the key is removed.

WARNING

Do not remove the key while driving. It will lock the steering and can cause loss of control. Remove the key only when the vehicle is parked.

ACC

By turning key to ACC position power supply to accessories is switched ON.

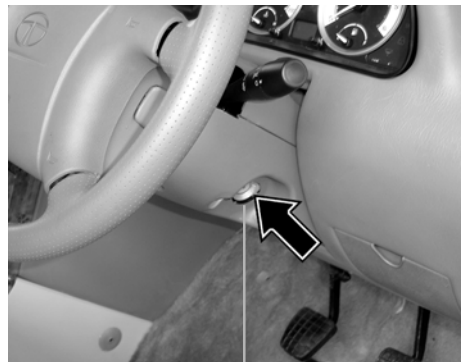

ON

By turning key to this position all the remaining electrical systems become operative. The glow plug indicator lights up. After a few seconds depending on the ambient temperature it goes off. The engine is ready for cranking.

START

Turn the key further clockwise to the START position (spring loaded) to start the engine. As soon as the engine starts release the ignition key to ON position.

NOTICE

Do not crank the engine more than 10 secs. continuously. If the engine does not start wait for 30 secs. before cranking it again.

Release the key immediately after starting the engine otherwise starter motor/ flywheel ring may get damaged.

By turning the ignition key from ON position to ACC or LOCK position, engine can be stopped.

Anti-theft security system - Immobiliser (If fitted)

Remote operated anti-theft security system (Immobiliser) along with central locking system is fitted on the vehicle.

Pressing the search push button on remote will result in flashing of turn indicators. This helps in locating the vehicle (vehicle search) in the parking. By pressing unlock push button of remote will unlock all doors and then inserting / rotating key in the ignition switch, vehicle can be started. By pressing lock push button on remote all doors of vehicle gets locked and lock indication in the instrument cluster starts flashing ensures automatic activation of immobiliser. For details refer Electronic security system manual given in the vehicle.



Parking Brake

To apply the parking brake, pull the parking brake lever fully up and leave it.

To release it, lift the lever up slightly keeping the release button pressed and then push down the lever fully.

The parking brake indicator on the instrument panel will go 'off' when the parking brake lever is fully released.

NOTICE

Driving the vehicle with the parking brake 'ON' will cause damage to the rear brakes and the clutch.

Gear Shift Lever

It is console mounted. The different gear positions are marked on the knob.

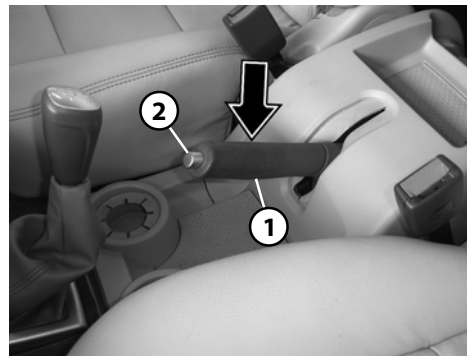

1. Parking Brake Lever 2. Release Button

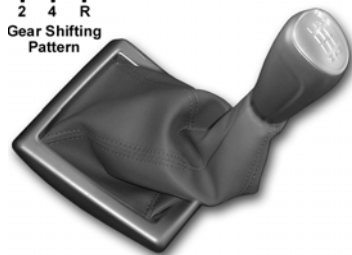

Gear Shifting Pattern

SCHEMATIC DIAGRAM OF COMBI SWITCH FUNCTIONS

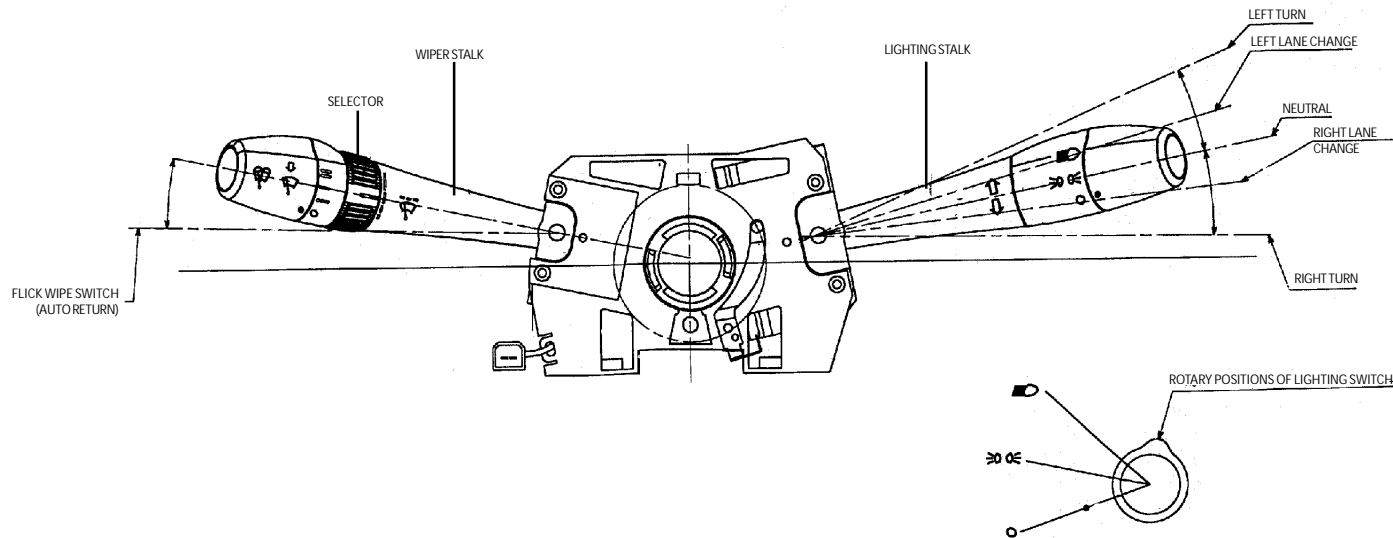

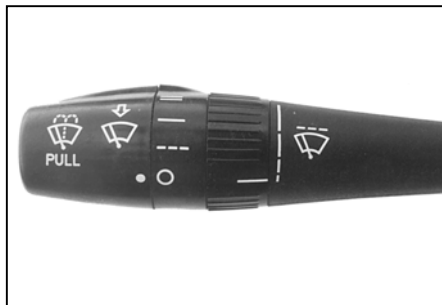
WIPER CONTROL COMBI-SWITCH LEVER - LEFT

Wiper 'OFF' Position



Intermittent Wipe

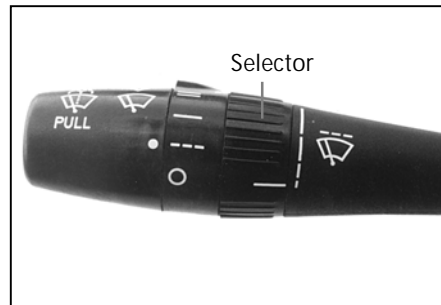

Rotate selector to set delay timing for intermittent wipe



Slow Wipe

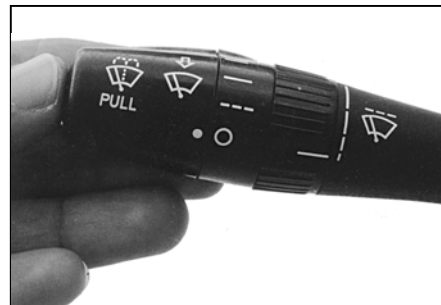

Fast Wipe

Pull upward for windshield wash and wipe.
Pull towards driver for FLICK WIPE (Spring Return)



Head Lamp 'OFF' Position



Position Lamp - 'ON'



Position Lamps & Head Lamps - 'ON'



toggling the lever in upward direction changes Low beam to High beam and vice versa. For High beam flash, pull up the lever halfway.

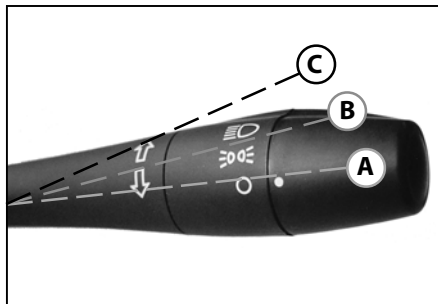

- A - Side indicator 'OFF'
- B - Lane change left side indicator (Spring Return)
- C - Left turn side indicator self Cancellation / Manual return

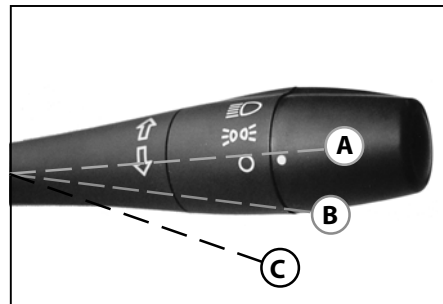

- A - Side indicator 'OFF'
- B - Lane change right side indicator (Spring Return)
- C - Right turn side indicator self Cancellation / Manual return

Transfer Case Electric Shift Switch :

It is electrically operated and mounted on dashboard below the instrument cluster. It is a gear selector switch. It has 3 different gear positions 2H, 4H and 4L. They indicate -

2H - 4 x 2

4H - 4 x 4 High

4L - 4 x 4 Low

Shifting from 2H to 4H or 4H to 2H :

Shifting can be done upto speeds 65 kmph.

Shifting from 4H to 4L or 4L to 4H :

Shifting to be done on stationary vehicle.

Important : Do not march the vehicle till 4H/4L indicator lamp stops blinking.

(One lamp glows on when shifted from 2H to 4H)

(Both lamps glows on when shifted from 4H to 4L) for free wheeling of front hub - see page 78.



Selector Switch

Steering wheel position Adjustment (For Low Pivot design steering column)

You can adjust the steering wheel position to suit your convenience.

Adjust the steering wheel position as follows before you start driving.

1. Adjust the seat to the comfortable position.
2. The lever to tilt the steering wheel is under steering column. Push the lever to unlock the steering column.
3. Move the steering wheel up or down to the desire position. Position the wheel such a way that all the instrument panel gauges and warning light are visible.
4. Pull the lever to lock the steering column once steering column position is fixed. Make sure that steering wheel is securely locked by moving up and down.

⚠ CAUTION

Steering wheel should be adjusted only when the vehicle is stationary.

NOTICE

This type of 'Steering wheel position adjustment' arrangement is applicable only for **Non-Air Bag** Versions like Lx & Ex.



Steering Wheel Position Adjustment

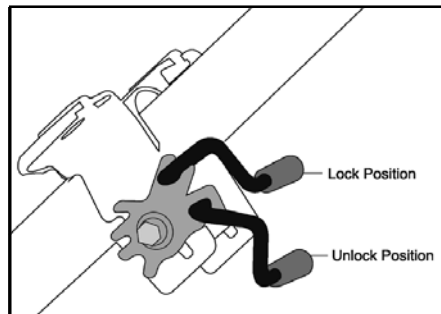

Operating Switches

Eight numbers of operating switches are provided on the console.

Front Fog Lamps (if fitted)

The fog lamps are provided on the front bumper to improve the visibility in Foggy weather. The front fog lamp can be switched on with the parking lamp on and can remain on till the parking lamp is switched off.

The switch for the front fog lamp is an 'ON / OFF' spring return type switch.

Rear Fog Lamps (if fitted)

The rear fog lamp has the in-built tell tale indicating lamps for indicating the fog lamp operation.

Fuel Tank Flap

To open the fuel tank flap press the operating switch. The solenoid provided near the fuel tank flap releases the fuel tank flap open.

To close the fuel tank flap just push the flap manually to its original position.

NOTICE

Do not operate fuel flap switch repeatedly. Once the fuel tank flap facia switch is operated, wait for 15 sec. before you operate again.

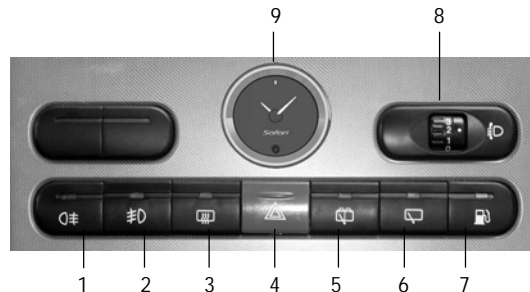

Operating Switches

1. Rear fog lamp
2. Front fog lamp
3. Rear Windshield & Outside Mirror Demister
4. Hazard Warning
5. Rear Windshield Washer
6. Rear Windshield wiper
7. Fuel flap opening
8. Headlamp leveling switch
9. Analog clock

Rear Windshield & Outside Rear View Mirror Demister (if fitted)

Push the operating switch on the facia to turn the demister 'ON'. The demister will switch off automatically after 15 minutes.



NOTICE

Clean the rear windshield glass carefully from inside to avoid any damage to demister heater element.

Hazard Warning

Push hazard warning switch on the facia switch. This will switch 'ON' all the outside turn signals and both indicators in instrument panel to flash simultaneously to warn the other road users about the hazardous condition of the vehicle.



CAUTION

If lights do not blink or blink rapidly, it is an indication of problem in the blinker electrical system or the indicator bulb at front or rear has fused. Get it rectified immediately.

Rear Windshield Wash & Wipe (Unlatched Switch)

Push and hold the switch knob for the operation of the wash function for the desired duration for rear visibility through glass. The function indicator lights up when wash function is 'ON'. Along with wash fluid getting sprayed, the wiper also operates with a delay to wipe the glass surface, through a timer control unit. On release of the switch, this function stops.



Rear Windshield Wiper (Latched Switch)

Push to switch 'ON' - Push to switch 'OFF'

The function indicator lights up when the wiper function is 'ON':

All the above switches have 'ON' indication except for hazard warning switch.



Head lamp levelling Switch :

A motorised head lamp levelling arrangement with the setting knob at the dash board is provided on the central console. As and when required, head lamp levelling, setting is done by rotating the knob to select one of the 3 levels marked on the knob depending upon the loading of the vehicle.



Loading Condition	Switch position
Unladen / Driver / Driver + Co-driver	0
Driver + Co-driver + All seats occupied	1
Laden + All seats occupied	2
Laden + All seats occupied + permissible luggage load	3

NOTE: Since the leveling switch takes care of headlamp focus pattern under different load conditions; it is advisable to select the correct position before starting a trip (depending on load)

This section gives you information on various indicators and gauges provided on the dash board and how to make use of these provisions while driving.

- **Instrument Cluster**
- **Indicators**
- **Gauges**

INSTRUMENT CLUSTER

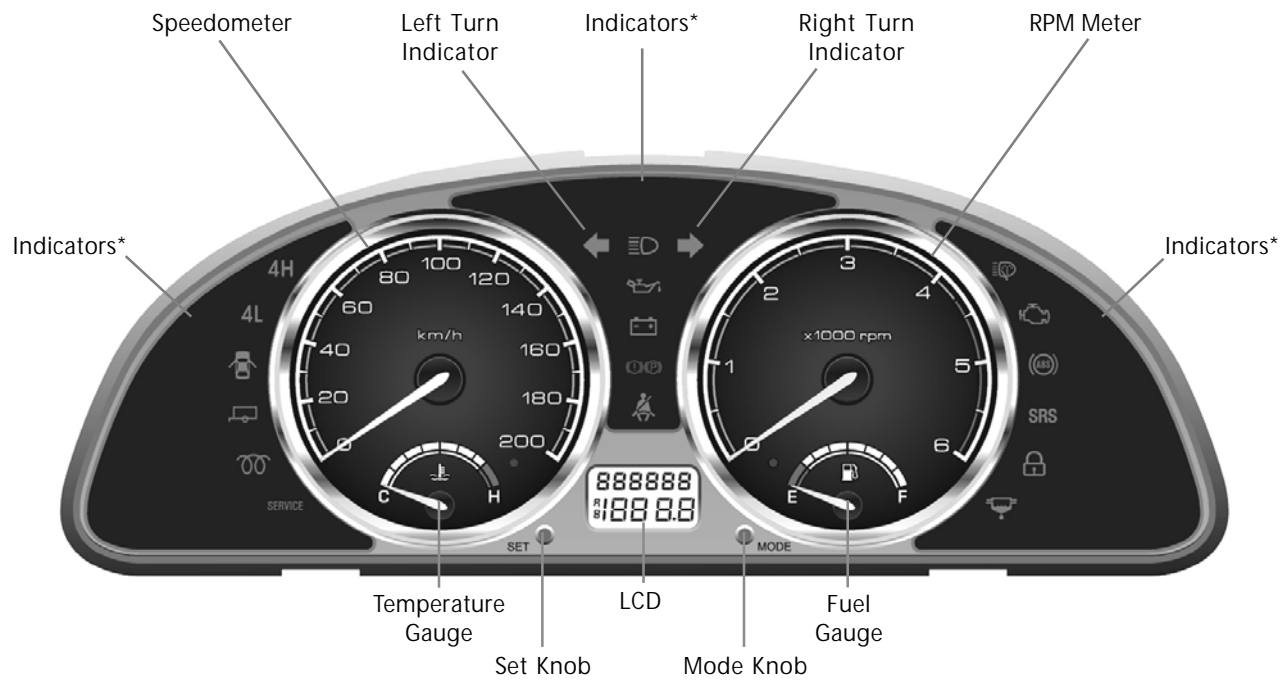



*** All indicators may not be provided on some cluster**

Turn Signals Indicators



Turn signal lamps can be operated only when the ignition supply is 'ON' and by using the turn indicator switch on the combiswitch.

The direction indicator arrow  (LHS) &  (RHS) on the instrument cluster flashes along with external indicator lights as selected.

Parking Brake and Low Brake Fluid Indicator



When the parking brake is applied this indicator illuminates. Ensure that the parking brake is fully released and this indicator goes off while driving.

When you turn the key to IGN position this indicator illuminates for few seconds and goes off automatically. It remains 'ON' when brake fluid level in the master cylinder container is low.

CAUTION

Do not drive the vehicle if the brake fluid level indicator remains 'ON'. Get the defect rectified.

High Beam Indicator



This light illuminates with the head lamps in high beam position.

Low Oil Pressure Indicator



This indicator light will glow when the oil pressure in the running engine drops low enough to cause damage to the engine.

It should light when ignition is 'ON' and should go off when engine is running.

If this light glows when engine is running, it indicates serious problem in engine lubrication system.

Safely pull to the side of the road and shut off the engine as soon as possible.

Continuously glowing of light indicates fault in lubrication system.

NOTICE

Do not run the engine when low oil pressure, indicator light is ON. In such a case contact the nearest authorised workshop for rectification of fault.

Battery Charging Indicator



This light should come ON when ignition is 'ON' and should go off after the engine starts. If it remains 'ON' when engine is running, it indicates battery is not getting charged.

In such a case, avoid using electrical loads and get the problem attended at an authorised workshop.

4H, 4L Indicator *

(* For 4WD model only)



With ignition 'ON' and transfer case switch in 2H mode both 4H and 4L indicator lamps on instrument panel should glow for a few seconds only and go 'OFF'.

Continuous illumination indicates an electrical fault. Do not run the vehicle if both 4H and 4L lamps are ON.

The 4H or 4L lamps will glow only when the transfer case is either in 4H or 4L mode.

Low fuel Indicator



If this warning light illuminates, it means there is a little fuel approximately 10 litres in the tank and you should fill the tank at the earliest.

ABS Indicators

(Where ABS is fitted)



ABS indicator light on instrument cluster illuminates approx. for 5 sec. when the ignition key is turned to 'ON' position. This is normal and indicates the system is performing a self check. If the light does not illuminate when ignition is 'ON' or remains illuminated after initial self check and while driving or flashes, fault may exist in the ABS system.

In this case also the normal braking system is still effective and can able to provide normal stopping ability. Even though we recommend taking the vehicle to the nearest dealer and inspecting your car as soon as possible if the warning light stays on.

Electronic Brake Distribution (EBD) indicator



If the ABS and the brake system indicator light comes together even after the parking brake is fully released, then the Electronic Brake Distribution (EBD) i.e. the front to rear brake force distribution system is also not working. This will lead to the rear wheel lock while braking. Avoid sudden hard braking and take the car immediately to the nearest dealer to fix the system.

SRS Indicator (Where air bag is fitted)

SRS

SRS indicator light on instrument cluster illuminates approx. for 5 sec. when the ignition key is turned to 'ON' position. This is normal and indicates the system is performing a self check. If the light does not illuminate when ignition is ON or remains illuminated after initial self check and while driving or flashes, fault may exist in the system, get the defect rectified by authorised service outlet.

'SERVICE' Indicator

SERVICE

This lamp indicates engine condition, when a malfunctioning occurs in Engine/ Engine Management System (EMS). This lamp indicates as below :

1. Comes 'ON' when key is in 'IGN' position and goes 'OFF' when engine is running.
2. remains 'ON' in engine running if malfunctioning occurs.
3. When 'SERVICE' indicator is 'ON' during running, engine performance (power) deteriorates marginally in some cases and drastically. In few cases, please get the malfunctioning rectified from nearest authorised service outlet as soon as possible.

Water in fuel sedimenter Indicator



This light indicates excess water accumulation in sedimenter which will come 'ON' when ignition is turned 'ON' and will go 'OFF' in 5 sec. When this lamp comes 'ON', water needs to be drained from sedimenter immediately. (Please refer page 109 for location and procedure).

When the indication comes 'ON' the vehicle will run on 'Limp home mode' where there is a drastic reduction in the performance of the vehicle.

CAUTION

If water is not drained from the sedimenter it can cause serious damage to the fuel injection system.

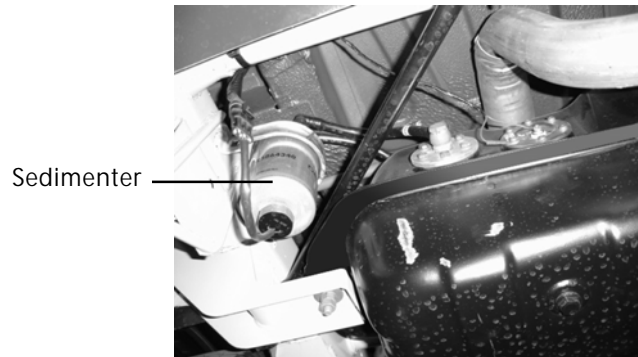

Malfunction Indicator Lamp - MIL (if installed)

This lamp comes 'ON' with ignition and it should be 'OFF' after cranking the engine. For any engine sensor related fault due to which emission of the vehicle may cross the regulatory limit, MIL lamp comes 'ON'.

CAUTION

MIL illuminates / flashes when a malfunction occurs in the engine emission system. Do not drive the vehicle if this indicator remains 'ON' or Flashes. Get the problem attended to immediately at a TATA Authorised Service Outlet. Driving the car in this condition may cross the regulatory emission limit and / or damage the catalytic convertor.

Seat Belt Indicator :

This indicator comes 'ON' with ignition and goes 'OFF' whenever the drivers seat belt is fastened.

**Lock Indicator Warning Light :**

If it blinks on the dashboard, vehicle can not be driven without pressing UNLOCK button on the User remote.



Speedometer, Main Odometer and Tripmeter (on LCD) :

The speedometer indicates the car speed in km/hr. The odometer records the total distance the car has been driven. The tripmeter can be used to measure the distance travelled on each trip or between fuel fillings.

CAUTION

Keep track of the odometer reading & follow the maintenance schedule regularly for meeting service requirements.

Odometer, Tripmeter and Illumination intensity control on instrument panel (LCD) :

The instrument panel has an LCD to display the following :

Main Odometer (Non- resettable) - Counts upto 999999 kms

Tripmeter A (Resettable) - Counts upto 1999.9 kms

Tripmeter B (Resettable) - Counts upto 1999.9 kms

Ambient display and Digital Clock display

Intensity level of instrument panel illumination - selection among preset levels.

LCD has two line display. The first line displays the Odometer count. The second line displays either of Tripmeter A, Tripmeter B, Intensity level of panel illumination, Ambient temperature and Digital clock display.

The selection and control of functions are done through 'MODE' and 'SET' push buttons (knobs) provided on either side of the LCD.

The 'MODE' knob is used to select one of Tripmeter A, Tripmeter B Ambient temperature , Digital clock display and Intensity level of panel illumination.



Speedometer

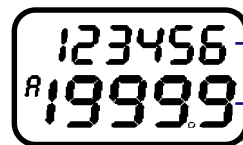

Display for Trip - A

Odometer

Tripmeter
or Intensity level of
panel illumination

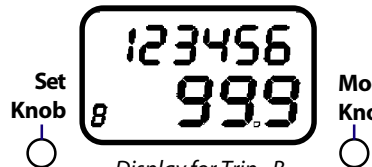

Display for Trip - B

Set
Knob

Mode Selector
Knob

Procedure for digital clock setting :

1. The clock can be set using both the 'SET' and 'MODE' keys.
2. Pressing the 'SET' knob for 5 secs. will cause the displayed time to flash i.e. clock setting mode.
3. At entry into clock setting mode, Hours digit will flash first.
4. While the Hours data is flashing, pressing and releasing the SET key will toggle between minutes and hours.
5. While the numbers flashing, pressing the MODE the key will advance the displayed number.
6. While the numbers are flashing, if no keys are pressed for 5 secs. Then the current value displayed are stored and the display stops flashing.

RPM meter :

The meter indicates engine speed in revolutions per minute (rpm)

Change gears at appropriate engine rpm and car speed to get optimum fuel economy.

The permitted engine rpm upper limit is the start of Red Zone on the dial.

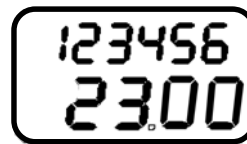

Digital Clock



RPM Meter

Temperature Gauge

The gauge indicates the temperature level of the engine coolant. The red zone at 'H' indicates temperatures higher than normal.

Avoid driving, when the pointer is in the red zone. It indicates engine overheating, which may be due to insufficient coolant in the radiator or due to any other defect. Take the car to the nearest Authorised Service outlet for necessary attention.

⚠ CAUTION

Never remove the radiator pressure cap from radiator when the engine is hot. Do not restart the engine until the problem has been duly attended.

Fuel Gauge

The fuel gauge indicates the approximate fuel level in the tank.

Refill the fuel tank before the needle touches the coloured band on the gauge. At this point, fuel level in tank is low and it is advised to get fuel filled immediately.

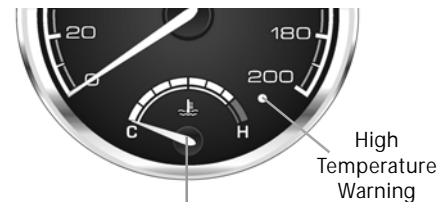

Temperature Gauge

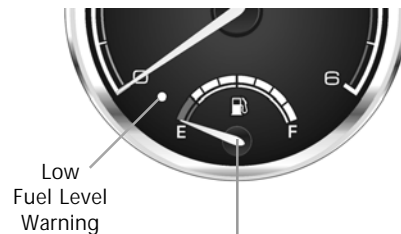

Fuel Gauge

COMFORT AND CONVENIENCE

This section gives you information on the different comfort and convenience features provided in your vehicle.





There are many features as listed alongside in TATA SAFARI.

To get the maximum benefit from these features, please read information in this section.

- **Air conditioning and heating**
- **Front windshield and door glass demister**
- **Power windows**
- **Front seat**
- **Headrest**
- **Middle seat**
- **Armrest cum cup holder**
- **Jump seats (if fitted)**
- **Jack & tools**
- **Motorised rear view mirrors**
- **Cigarette lighter and ash tray**
- **Fuel filler flap**
- **Mechanically Operated Fuel Tank Flap**
- **Glove box**
- **Inside rear view mirror**
- **Sun visors**
- **Interior roof lights**
- **Reverse guiding system**
- **Analog Clock**
- **Music System**
- **MP3 / DVD Player**
- **Tail Lamp**
- **High Mounted Stop Lamp**

Air Conditioning / Heating

Your vehicle is fitted with heating and air conditioning system. The controls are provided on dash board. For rear seat A.C. comfort direct middle vents on the dash board to rear middle seat. The system controls can be adjusted to mix air into various combinations. The air flow for different locations is controlled by air flow direction control knob fitted on RH side of A.C. control panel. The air flow switch has five positions for air flow direction.

- 
Face position -
Air flows to upper parts of body
- 
Face / foot position -
Air flows to body and foot
- 
Foot Position -
Air flows to foot only
- 
Air to foot and windscreen -
recommended for clearing mist on
windscreen
- 
Air to windscreen -
recommended for
clearing heavy fog or snow

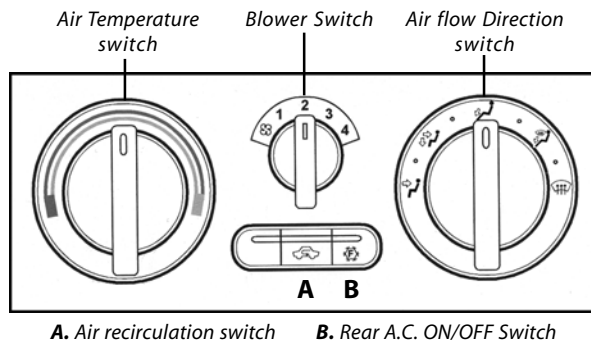

A.C. Control Switches on Central Console



The air mix control switch is on the LH side of the panel. By rotating the control switch clockwise (towards red segment) the air temperature from vents will increase. Rotate anticlockwise (towards blue segment) to reduce the air temperature. The switch on the top centre is for the 4 speed blower. Any of the blower speed could be chosen as per requirement. The 2 switches at the centre are for A.C. control as follows:

Switch 'A' - Press for recirculation mode. Release for fresh air.

Switch 'B' - For switching 'ON' or 'OFF' front cooling. It is marked by 'F'

NOTICE

When the A.C. is switched ON the engine low idling RPM increases marginally to adjust for A.C. compressor load. When the thermostat cuts off A.C., engine idling RPM decreases to lower adjusted value.

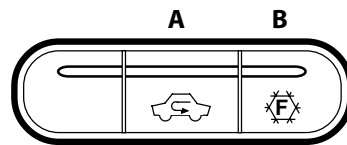

A. Air Recirculation Switch

B. Front A.C. ON/OFF Switch

Roof Mounted A.C. Unit (if fitted)

The roof mounted A.C. unit is installed on your vehicle. The blower switch has 4 positions - '**HIGH**', '**MEDIUM**', '**LOW**' and '**OFF**'. The switch is located on LH side of roof A.C. console. Air flow direction can be adjusted by adjusting the air vents.

The roof AC can be switched on provided the front AC is 'ON'. However, the blower of the roof AC unit can be operated independently.

Front Windshield and Door Glass Demister

To remove frost or ice from the windshield and side windows, quickly.

1. Start the engine & accelerate to warm up.
2. Select defrost/demist mode on air flow direction control.
3. Set blower and air mix temperature control to maximum hot.

These settings direct all air flow to the defroster vents at the base of windshield and side window defroster vents. The hot air flow clear the frost from windows.

Make sure you have clear view through all windows before driving. You may turn back air mix and air flow control to desired position, while driving.

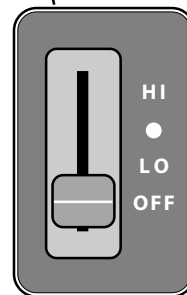

Roof A.C. Blower Switch

Power Windows :

Glasses on all four windows of your vehicle can be operated by switches provided on the main control panel located on the driver's arm rest. They work only when the key is in the "IGN" position.

Glasses are wound up by pulling the switch and are lowered by pressing it down. If you would prefer to have the glass at its lower most position, press the switch down a little longer and the glass glides down. This feature is known as "Express Down".

A safety locking arrangement has also been provided and can be activated by a push type switch located at the centre, below the window switches. It has two positions:

LOCK – When switch is pressed

UNLOCK – When switch is released

When the switch is in "LOCK" position, the rear window switches (located on rear doors) do not function. The rear window glasses can still be operated by using the switches on the console. Illumination on the rear window switch goes off when the switch is in locked condition. Press down the lock button to unlock.

Individual window winding switches have been provided only on other doors.

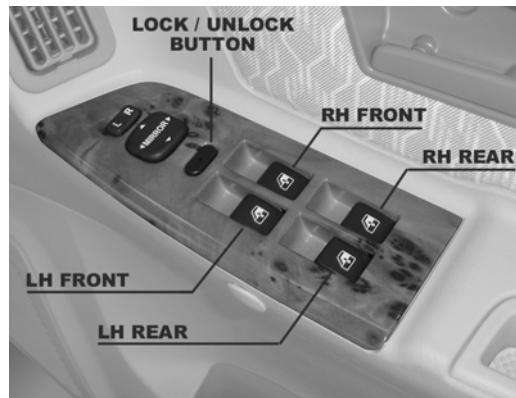

Power Window Switch on Driver Door

WARNING

While raising the glass, take care to avoid fingers / hands getting trapped between glass and the frame.

Front Seats

Both driver and co-driver seats are provided with arm rest and Seat height can be adjusted by lifting up / pushing down the lever (2) to give you maximum driving comfort.

In few version, both front seats are also provided with lumbar support (4) to give you maximum driving comfort.

The lumbar support is adjusted by using the lever provided at the side of the seat back rest.

Seat Adjustment

Adjust the seat before you start driving. To adjust the seat forward and backward, pull the lever (3) below the seat cushions front edge.

Move the seat to the desired position and release the lever. Try to move the seat to make sure it is locked in position. To change the angle of the seat backrest use the recliner level(1). The recliner lever is located at the base of the seat on RH side for driver seat and LH side for co-driver seat.



1. Seat backrest reclining lever
2. Seat height adjustment lever
3. Seat adjustment (forward/backward) lever
4. Lumbar Support



CAUTION

The seat back in rear will reduce the protection you get from your seat belt in a crash. Adjust the seat backrest to an upright position and sit well back in seat.

Headrestrest

The front seats have headrestrest. They protect front seat occupants from whiplash and other injuries in the event of impact. For best protection, adjust the centre of the headrestrest so that it is in the same level as your ears.

Drivers seat occupant should not adjust headrestrest while driving. It is unsafe.

To raise headrestrest, pull it upward.

To lower, push the headrestrest down.

CAUTION

Ensure headrestrest are adjusted before driving.
Take care of electrical wiring for LCD monitor, while removing the headrestrest.

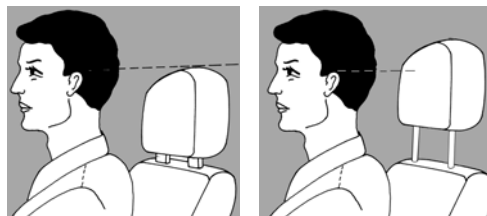

Poor Adjustment

Good Adjustment



Middle seat

Middle Seat (60:40)

Middle seat is in 2 parts (60:40). Space for two occupants is at RH side and space for single occupant is at the LH side. These seats can be independently folded, as & when required for carrying long objects. The RH side seat backrest is provided with latch for folding at RH back and LH side seat back is provided with latch for folding at LH back. Pulling the latch to the front allows the seat back to fold.

For keeping the seat back upright just push back the seat up till it gets locked in the latch pin.

Folding of Middle Seat

The seat base is provided with folding arrangement so that you can fold the rear seat forward. To fold the rear seat, first delatch seat back by pulling lever (1) and rest on the seat base.

After rear seat backs are folded pull the lever (2) provided at the seat base sides and take the respective seat base up so that it is vertical.

To keep seat base horizontal, simply push back the seat base.

This folding feature gives additional space for keeping luggage.

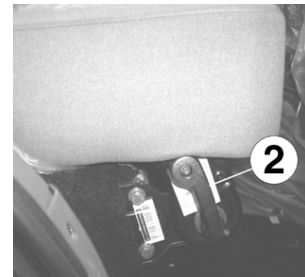
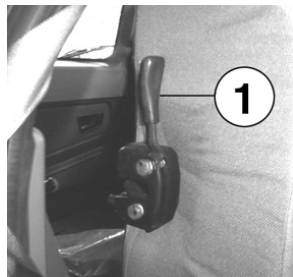

Arm Rest cum Cup Holder

Arm rest cum cup holder is provided at the centre of middle passenger seat backrest.

To use as an armrest - Pull out the strap at the top end and rest it on the seat in horizontal position.

To open cup holder - Press the knob to open the arm rest lid and swing out the cup holders.

Place back the cup holder into the arm rest box and close the lid, when it is not in use.



Arm Rest



Cup Holder

Jump Seat (if fitted)

The jump seats with hinges are provided at the rear side of the vehicle. Jump seats can be folded to get increased luggage space when needed.

**Tools**

Tools are placed on floor below the (RHS) rear seat. To access the tools fold the rear seat forward, set aside the floor carpet.

Rotate the pinion anticlockwise & take out the tools. Rotate the pinion clockwise to fit against the seat.

Jack

Jack is placed in vehicle below the right hand side rear jump seat, which can be accessed by opening the tail gate.



Jack

Motorised Rear View Mirror

Motorised Rear View Mirrors are fitted on both front doors and can be adjusted to the desired position with the help of a switch provided on the driver side door.

Motorised Rear View Mirrors allow the driver to adjust the mirrors without lowering the glasses and without moving from his position.

1. Move the main switch to L (for left side) and R (for right side)
2. Use the 4 positions of the knob to adjust the rear view mirrors to correct angles.

These mirrors are provided with demister. The switch is commonised with Rear windshield demister.

Cigarette Lighter and Ash Tray (Front)

With ignition switch in 'ACC' position, press the cigarette lighter fully in. When heated to specified temperature it pops out. Take the lighter out and light your cigarette. After use place the lighter in its position.

NOTICE

Do not insert any other part or accessory in cigarette lighter slot. It may damage cigarette lighter.

Do not attempt to touch the hot coil. It may cause scalding.

Ash tray is provided near cigarette lighter for occupants of front seats. To open ash tray press the lid gently.



Motorised Rear View Mirror Switch

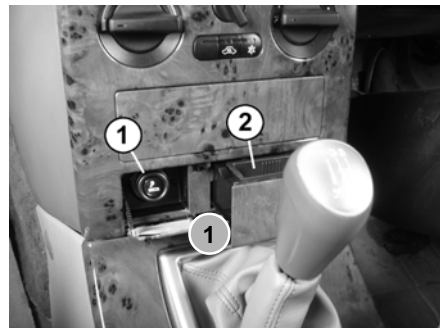

1. Cigarette Lighter 2. Ashtray

Cigarette Lighter and Ash Tray (Rear)

The cigarette lighter is also provided on the console (below air vents). Ash tray is also provided near cigarette lighter for occupants of rear seats.

To open ash tray pull it out by sliding.

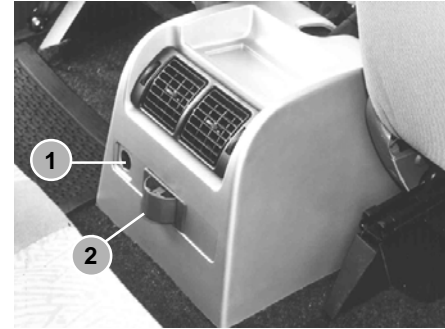

1. Cigarette Lighter 2. Ashtray

Fuel Tank Flap

It is operated by the switch provided on the dash board centre panel. To open the fuel tank flap press the operating switch. The solenoid provided near the fuel tank flap releases the fuel tank flap open. To close the fuel tank flap just push the flap manually to its original position.

In case of battery run down the fuel tank flap can be opened manually. First open the tail gate and pull the nylon rope to open the fuel flap.

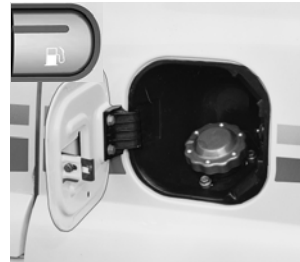

Mechanically operated fuel tank flap (if fitted)

Fuel tank flap opening lever is provided below driver seat on right hand side. To open flap, pull the lever up and to lock simply close the flap.

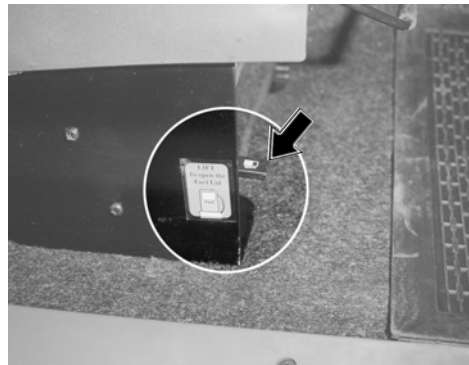

Mechanical fuel tank flap
opening lever

Glove Box

Glove box is located on the co-driver's side of the dashboard. The glove box can be locked by the key common for ignition and door.

The glove box lamp will glow when the glove box lid is opened and will go off as soon as the glove box lid is closed.



Glove Box

Inside Rear View Mirror

An additional antiglare rear view mirror is fitted inside the cab.

Use antiglare position only when necessary because it reduces rear view clarity.

Sun Visors

Two adjustable sun visors are provided inside the cab to prevent sun glare.

Lower the sun visor to protect the eyes from the bright sun light. The sun visor also moves side ways towards the door window.

The back of co-driver sun visor is provided with a vanity mirror.



⚠ CAUTION

Always return the sun visor to its original position when not required. It may block driver's vision.

Interior Roof Lights

The roof lamp has three positions ON, OFF and DOOR. When the switch is in DOOR position and if you enter in the vehicle and close the door the roof lamp will not go off immediately. It will continue to glow for a few seconds and allow you to settle and insert the ignition key in the switch.

However if you switch on the ignition before 15 seconds, the roof lamp goes off gradually.

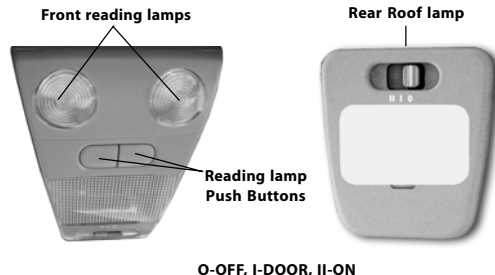

“Follow me home” Headlamps :

After closing the door, your car's headlights remain ON for approximately 30 seconds to help you reach your destination in the dark.

If the car's headlamps remain ON for five minutes or more and when switched off, ignition key removed and the door locked or kept open, the headlamp's Low-beam comes ON automatically for approximately 30 seconds to help the car occupant reach his / her destination safely. If, within 15 minutes, the car is locked using a remote key, the headlamp will come ON for a further 30 seconds. If the remote key is used again within 15 minutes, this procedure is repeated. If the occupant returns to the car within 15 minutes after last switching it off, the headlamp again comes ON when the door is unlocked.

(Please note – The repeatability function of the Headlamps coming ON again within 15 minutes is not available for the LX version)

Ultrasonic Reverse Guiding System :

The vehicle is fitted with ultrasonic reverse guiding system consisting of 2 ultrasonic sensors mounted on the rear bumper and LCD monitor provided on inner rear view mirror (IRVM).

These sensors detect the obstacle behind the vehicle within the sensing zone which can not be viewed by internal rear view mirror and outer rear view mirrors and shows visual indication on LCD monitor with audio warning. This helps the driver to get indication of obstacle at rear side of vehicle while reversing.

How Ultrasonic Reverse Guiding system work:

Switch on the ignition; display in the IRVM will blink once indicating the system is healthier. On engaging the gear in reverse at speed less than

5 Kmph. systems will get activated automatically. When the obstacle comes in the sensing zone, system start giving audio & visual indication depending upon distance from spare wheel cover. Lesser the distances of obstacle from spare wheel cover shorter will be the interval between the beeps.

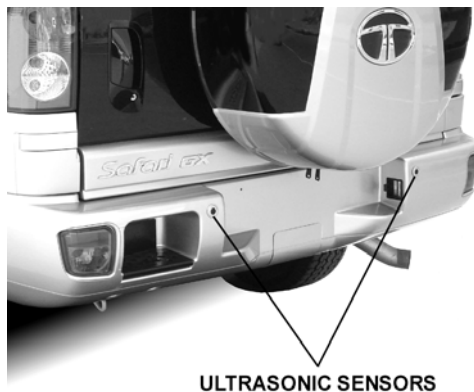
**ULTRASONIC SENSORS**

SENSING RANGES AND RELATIVE INDICATION ON LCD ARE AS FOLLOWS:

- Obstacle at above 1.3 M - No indication
- Obstacle between 1.3 M – 1 M - Green Zone, Slow beep
- Obstacle between 1 M – 0.6 M - Amber Zone, Fast beep
- Obstacle between 0.6 M – 0.3 M - Red Zone, Continuous beep with STOP display.

NOTE: In some cases, the display may not be as same as the reality due to the obstacle shape, reflection condition, technical limitation of the sensor etc. Some examples are given.

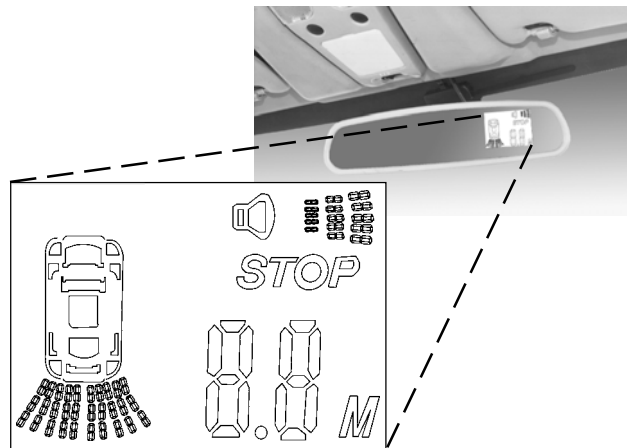

Obstacles in the blind zone can not be detected by the system

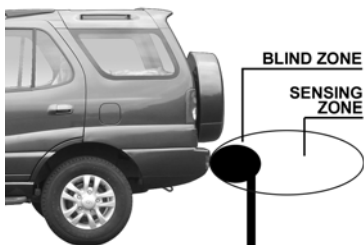

Obstacle can't be detected it is too high

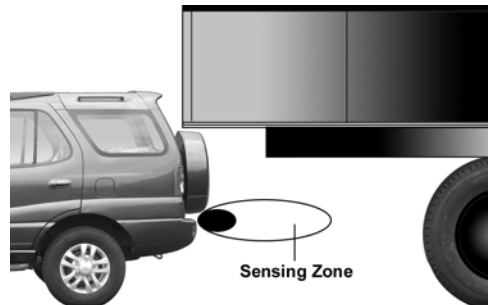

CAUTION

1. System performance is dependent on the reflection angle of ultrasonic waves from the obstacle.
2. System cannot sense the wire mesh, handrail, small objects & some obstacle which are coming too much below or too much above the bumper level.
3. System cannot sense the obstacles like cotton, wool, foam, textile or spongy surface which will absorb ultrasonic waves easily.
4. System may give wrong signal on reversing the vehicle on grasslands & bumpy roads.
5. System may give wrong signal while vehicle moving from plain ground to slope like backing up downhill or vice versa.
6. System may give wrong signal by sensing the ground when the bumper is tilted more than the normal position or when the vehicle is heavily overloaded.
7. System may give wrong indication when the temperature of the obstacle is high as hot surfaces reflect fewer sound waves less than cold surfaces.
8. System may give wrong signal if there is an excessive increase in humidity as it increases the sound speed (max. by 2%) as compared to dry air
9. System may give false alarm during the heavy rain conditions, during the snow conditions or heavy wind conditions.
10. System will not sense the pot holes or the trenches or drainages which are below the ground level.
11. Tilting of the spare wheel cover or rear bumper may cause system to malfunction by sensing the spare wheel cover or ground respectively.
12. System may give wrong indication when the vehicle is equipped with high power radio antenna on rear side.
13. Sensor may give wrong signal if sensor is at extreme temperatures: below -30°Celsius or above 80°Celsius.

MAJOR CAUTIONS

1. This system is strictly a driver assistance device. It is not a substitute of driver's responsibility while driving. Under no circumstances will the manufacturer accept any responsibility or can be held liable for any direct or indirect, incidental or consequential damage caused by negligent use of this system.
2. Clean the sensors properly and keep them free from ice, dust, mud, water, chewing gum etc. for proper working of the system.
3. Please practice reverse parking using different obstacles to grasp the system performance.
4. Pressing the sensor on active region may damage the sensors & may hamper its sensing range causing the system to malfunction.
5. Always STOP your vehicle when a continuous beep is heard. As it indicates an object at dangerous distance not more than 0.6M from the spare wheel cover.
6. Never use high pressure water to clean the sensors and also never use hammer on it.

Reverse Guiding System (if fitted)

This vehicle is fitted with reverse guiding system consisting of LCD monitor on inner rear view mirror and camera is mounted on the rear bumper. It helps the driver to see objects at rear side of vehicle while reversing.

The LCD monitor is operated automatically when reverse gear is engaged and vehicle key is in 'IGN' position.

To get clear view, monitor and camera lens should be kept clean. For cleaning the camera lens and LCD monitor, use moist and dry cotton cloth.

For more details, refer User's Manual.

NOTICE

Although camera installed at rear bumper are designed to assist reversing of vehicle by giving real image of rear view onto Rear View Video Display, its performance can be affected by dirty camera lens, insufficient light, improper display setting etc. Therefore the vehicle driver must take all necessary precautions while reversing the vehicle.

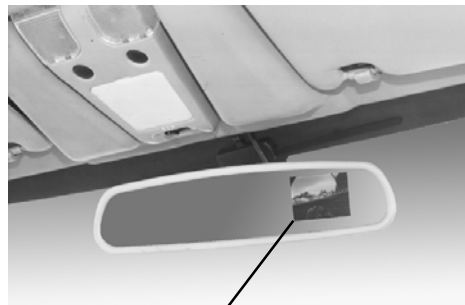

LCD Monitor



Reverse Guiding Camera

Analog Clock

This Vehicle is fitted with analog clock and powered by electrical system. It has knob at the bottom of dial for resetting time.

Music System (if fitted)

The head unit is fitted in the centre console, two speakers in front & rear door, two tweeters in the inner cover of outside rear view mirrors are provided.

The antenna is located on the front windshield glass behind inside rear view mirror.

Please follow the music system manufacturer's manual for operation possible on the music system

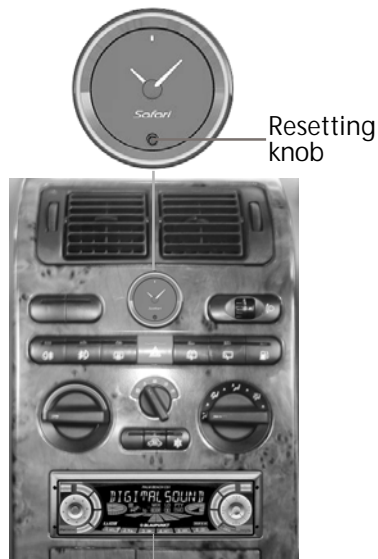

Music System

MP3/DVD Player : (if fitted)

Your vehicle comes installed with a MP3/DVD player with LCD colour monitors.

To operate, handle and maintain the system, please refer the Manufacturer's operator's manual, given along with car.

The LCD colour monitor is located on rear side of front seat headrest. The controls of the monitor are situated below the screen.

**LCD monitors****Tail Lamp :**

The tail lamp assembly incorporates the following :

1. Parking/Rear stop lamp
2. Rear Direction indicator
3. Reverse Light
4. Rear fog lamp OR Reflector on rear bumper.

Registration Plate Lamps :

Two concealed lamps are provided for illumination of the rear registration number plate.

High Mounted Stop Lamp :

High mounted stop lamp is incorporated in rear spoiler at the rear and it glows whenever service brake is applied.

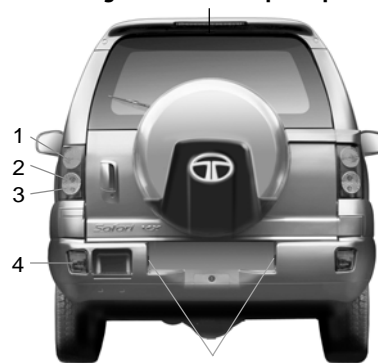
High mounted stop lamp**Registration plate lamps**

Before you start driving you should carry out important checks on your Safari. Please read this section carefully to know the procedure for carrying out important checks.

- **Opening bonnet**
- **Fuel level check**
- **Engine oil level check**
- **Engine coolant check**

Opening and Closing the Bonnet

1. Ensure that the vehicle is in neutral gear and apply the parking brake. Pull the bonnet release lever located under extreme corner of the dash board on driver's side. The bonnet will pop up slightly.
2. Standing in front of the vehicle, lift the additional lock lever located under the bonnet centre with a finger and lift the bonnet up. The bonnet will rise slowly with assistance of the balancers fitted on both corners of the bonnet.
3. To close the bonnet press down the bonnet till it is fully locked.

WARNING

Ensure that the bonnet is fully locked before driving off.

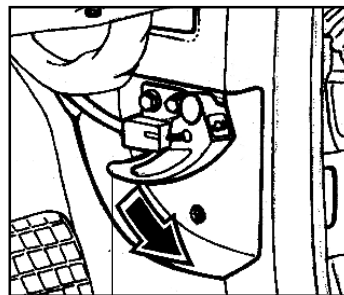

Bonnet opening lever

Additional lock lever under the bonnet centre



CHECK

- Fuel level (Refer page No. 72)
- Coolant level (Refer page No. 73)
- Engine oil level (Refer page No. 72)
- Tyre pressure (Refer page No. 124)
- Brake & clutch fluid level (Refer page No. 115)

ENSURE

- Gear shift lever in neutral position
- All switches & lamps working
- SRS, ABS, Brake fluid level indicator and Engine lamp goes off
- Parking brake released

ADJUST

- Driver Seat (Refer page No. 56)
- Rear view mirrors (Refer page No. 60 & 63)
- Steering column (Refer page No. 37)

Fuel Level Check

1. Check fuel level in tank. The same is indicated on the instrument panel.
2. If indicator is already in red zone remember to fill the fuel at nearest filling station.

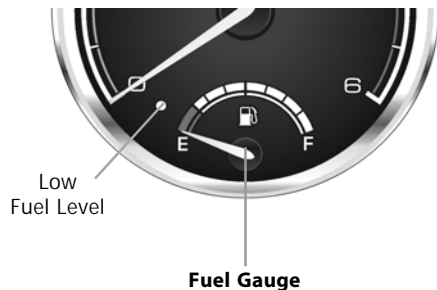

Engine Oil Level Check

Check engine oil level before starting the engine.

- A. Open the bonnet.
- B. Pull out the dipstick and wipe it with a cloth or paper towel.
- C. Insert it all the way back in its tube.
- D. Pull out the dipstick and look at the oil level at the end of the dipstick.

Top up oil if the oil level is below midway of minimum mark.

NOTICE

Oil level should not exceed the max mark. Check the oil level when vehicle is on level ground and wait for a few minutes after switching off the engine.

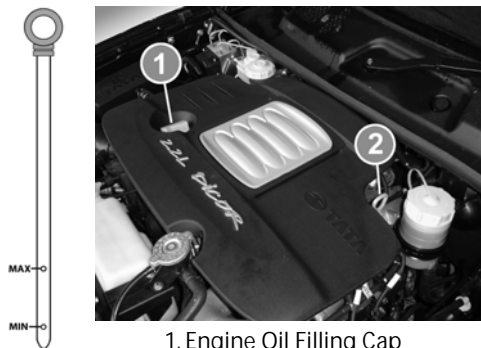

1. Engine Oil Filling Cap
2. Dip Stick

Engine Coolant Check

Check the coolant level in the radiator auxiliary tank.

It should be in between maximum & minimum lines.

If the auxiliary tank is completely empty, please check the coolant level in radiator as follows -

WARNING

Do not remove radiator cap when engine is hot. It may spray hot coolant on you causing serious injuries.

1. Ensure engine and radiator are cool.
2. Turn the radiator cap anti clockwise (without pressing it) until it stops. This will relieve the pressure, if any in the cooling system.
3. Remove the radiator cap by pushing down and turning anti clockwise.
4. The level of coolant should be upto the base of the filler neck. Coolant should be added if it is low.
5. Secure the radiator cap in its place.
6. Add coolant into the auxiliary tank up to the high mark.
7. Put the cap back, on the auxiliary tank.

NOTICE

Topping of the coolant should be done in the auxiliary tank only. Radiator cap should not be removed, if coolant is present in the auxiliary tank.



1. Auxiliary Tank 2. Radiator Pressure Cap

This section gives you important tips on how to start the engine, how to take care of turbo charger, operation of transmission and transfer case. It also includes important tips on safe driving in adverse conditions and difficult terrains.

The information on topics listed above would certainly help you in safe and carefree driving.

- **Starting & stopping the engine**
- **Preparing to drive**
- **Running-in period**
- **Gear change**
- **Brakes (Anti-lock brake system)**
- **Transfer case**
- **Fuel economy**
- **Four wheel driving system**
- **Limited slip differential**
- **Driving in adverse conditions**
- **Driving Safety**

Starting the Engine

Before starting

1. Apply parking brake.
2. Ensure gear lever in neutral.
 - A. Insert the key in steering cum ignition lock and turn it to 'ON' position.
 - B. Press the clutch pedal fully.
 - C. Now crank the engine.
 - D. If the engine does not start turn the key to off position and try after 30 seconds.

NOTICE

After starting run the engine in low idle speed for at least 30 seconds. Do not press accelerator pedal while starting the engine to avoid damage to turbocharger..

Stopping the Engine

Before switching off the engine, run the engine idle for atleast 30 seconds and then switch off. This will allow the engine oil to lubricate the turbocharger, till its speed is fully reduced and also allow the unit to cool down.

Above precautions will ensure satisfactory life and performance from the turbocharger.

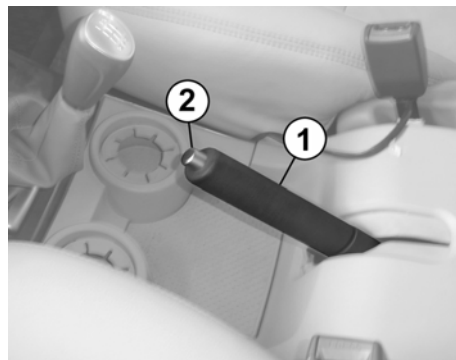

1. Parking Brake Lever 2. Release Button

Preparing to Drive

The following checks and adjustments should be done before you start driving the vehicle.

1. Ensure all mirrors, windows and outside lights are clean and unobstructed. Remove dust, frost, snow or ice if any, on these.
2. Ensure bonnet is fully closed.
3. Check that any items you may be carrying inside with you are stored properly or fastened down securely.
4. Check adjustment of seat. If required adjust to your convenience.
5. Check adjustment of all rear view mirrors.
6. Check adjustment of steering wheel.
7. If the doors are not properly closed you will get a audio warning/indicator light as soon as you insert the ignition key in the switch. Make sure all doors are properly closed and locked.
8. If the seat belts of driver & co-driver are not fastened you will get an audio warning as soon as you turn the key to ignition position. Fasten your seat belt, ensure co-driver seat passenger has also fastened the seat belt (see Your Safety).

9. Check and ensure that all the gauges and indicator lights in the instrument panel are working.

Running-in Period

Avoid rapid acceleration and prolonged high speed running of the engine while using the new vehicle for the first 1500-1800 km of operation.

Do not exceed the following vehicle speed during running in period.

Gear	2H/4H	4 L
	km/hr	km/hr
1st	20	8
2nd	40	16
3rd	65	-
4th	90	-
5th	110	-

Gear box

Gear box has all synchromesh gears including reverse. The 5th gear is an over drive.

When shifting the gear up or down make sure you press the clutch pedal fully and shift to the next gear and then release the clutch pedal gradually.

NOTICE

Do not rest your foot on the clutch pedal during driving. This can cause clutch wear and damage.

Before shifting in to reverse gear bring your vehicle to a complete stop and depress the clutch pedal fully.

Do not shift into reverse gear with vehicle moving forward. While shifting the gears it is recommended to shift at the speeds given in the table.

You can get extra braking from the engine when slowing down by shifting to a lower gear.

This can help you to maintain a safe speed and prevent your brakes from overheating while going down a steep hill.

NOTICE

Avoid excessive revving up of engine rpm.

Gear Change Speeds during upshift

Gear	Vehicle Speed during Up Shift	
	2H/4H	4 L
	km/hr	km/hr
1-2	20	10
2-3	45	18
3-4	70	-
4-5	90	-

Gear Change Speeds during downshift

Gear	Vehicle Speed during Down Shift	
	2H/4H	4 L
	km/hr	km/hr
2-1	15	06
3-2	25	-
4-3	45	-
5-4	60	-

Brakes

Tata Safari is equipped with ventilated disc brakes on front and drum brakes on rear wheels.

Braking system is vacuum assisted to reduce effort needed on the brake pedal. It is a dual circuit service brake system designed in such a way that one circuit will always work, even if other circuit fails.

If this happens you will immediately notice that the brake pedal goes down much farther and you need to press the pedal harder. In such an event the stopping distance may be longer.

In case of failure of vacuum the vehicle can still be stopped with a higher pedal effort.

In case of vacuum failure or brake circuit failure, slow down the vehicle by shifting to lower gear and lifting your foot from the accelerator pedal. Pull to the side of the road as soon as it is safe.

CAUTION

Brake system failure is very hazardous. It is best to have your vehicle towed, but if you drive the vehicle in this condition, be extremely cautious.

Have your vehicle attended immediately.

Put your foot on brake pedal to apply brake. Do not ride the brakes as they may overheat and the performance may be impaired. The brake lights may confuse the drivers behind you.

Use engine to assist the brakes by shifting to a lower gear and lifting your foot from accelerator pedal.

Constant application of brakes while going down the hill builds heat and reduces braking efficiency.

Check your brakes after driving through deep water. Apply the brakes moderately to feel that they are normal. If not, apply them gently and frequently until they do. With wet brakes you should be extra cautious and alert in your driving.

Anti Lock Brake System (ABS) – if fitted

ABS combined with the traditional hydraulic brake system prevents the wheel from locking while braking by make use of most of road to tyre grip. It also ensures better control and stability of car while braking.

How ABS works

ABS essentially consists of an Electronic Control Unit (ECU) which reads signals from the sensors fitted to each wheel and identifies the one which is likely to lock. (Wheels will tend to

lock when the speed of rotation of any one wheel becomes too low in relation to the vehicle speed.) It actuates an Electro Hydraulic Control Unit (HU) to reduce, maintain or increase the pressure on the brake control cylinder in order to prevent the wheel from locking. The ABS comes into play when the car is braked heavily during emergency.

The driver feels the effort of the ABS through the pulsating of the brake pedal and audible noise in the brake system.

This is absolutely Normal. This should not be interpreted as a fault in the brakes. On the contrary it's the indication that the ABS is working. This is an intentional warning to the driver that a wheel or wheels are tending to lock up due to the limit of tyre to road adhesion.

In this situation it is important to keep the brake pedal depressed fully so that the ABS can regulate the brake application. On No account pump the brake pedal

The ABS is addition to the basic brake system. **It is activated automatically every time the engine is started.** If there is a malfunction the system turns off automatically indicated by a **'(ABS)'** warning lamp on the dash board, still the ordinary brake system continues to work.

ABS Activation

ABS activation varies with various road surfaces i.e. the amount of traction your tyre have on a particular surface. On dry surface you will need more pedal effort to activate ABS. However you may feel ABS activates immediately if you try to stop on snow, ice or slippery surface.

ABS Indicators



The ABS is self check. If any thing goes wrong the ABS warning indicator comes on the instrument panel. **When you switch on the Ignition the ABS light turns ON but should go out after about 5 seconds. If the light fails to go or the lighting up of the warning light when the engine is running or the light comes at any other time, it indicates there is a fault in the ABS only. In this case also the normal braking system is still effective and is able to provide normal stopping ability.**

We recommend taking the vehicle to the nearest dealer and inspecting your car as soon as possible if the warning light stays on.

Electronic Brake Distribution (EBD) indicator



If the ABS and the brake system indicator light comes together even after the parking brake is fully released, then the Electronic Brake Distribution (EBD) i.e. the front to rear brake force distribution system is also not working. This will lead to the rear wheel lock while braking. Avoid sudden hard braking and take the car immediately to the nearest dealer to fix the system.

Safety tips while driving with ABS

- 1) During a hard braking or when the road grip is poor, you will feel the brake pedal is pulsating and an audible noise in the system. This is absolutely Normal and it's the indication that your ABS is rapidly pumping the brakes. Do not release the brake pedal, this defeats the purpose of ABS. Keep firm steady pressure on the brake pedal so as not to interrupt the braking action as long as you steer away from the hazard.
- 2) **ABS prevents the wheel from locking but it does not increase actual tyre to road grip.** Hence even if your car is fitted with ABS, maintain a safe following

distance.

- 3) **ABS does not reduce either time or stopping distance.** It only helps steering control during braking. You should always keep a safe distance from other vehicles.
- 4) **ABS will not prevent skidding of a car that results from changing direction abruptly** such as trying to take a corner too fast or making a sudden lane change.
- 5) **ABS cannot prevent a loss of stability due to severe or sharp steering wheel movement.** Always steer moderately while braking hard.
- 6) **ABS requires a little longer stopping distance than a vehicle with conventional brake system on a loose or uneven surface,** such as gravel or snow. Slow down and allow a safe following distance.
- 7) **ABS serves to increase your control over the car not to enable you to go faster.**

Transfer Case and Transfer Case Selector Electric Switch (If fitted)

On four wheel drive vehicles transfer case is fitted after the gear box for driving front live axle along with rear axle. The following 3 selector positions are provided on the knob.

- 2H** - Only two rear wheels are driven and transfer case operates at 1:1 ratio.
- 4H** - All four wheels are driven and transfer case operates at 1:1 ratio.
- 4L** - All four wheels are driven and transfer case operates at 2.48:1 speed reduction ratio.



4x4 Selector Switch



Automatic Hub Lock

For driving in 2H mode keep the selector knob in 2H position.
 (*For 4WD model only)

Automatic Hub Locks

While driving in 2H mode this mechanism on the front axle hub allows the hub to free wheel. This avoids the unnecessary spinning of front drive components and results in fuel saving, reduced noise and longer component life.

As soon as 4H or 4L mode is selected the hub gets automatically connected to front drive line to increase the traction.

Limited Slip Differential

(Standard on 4x4 and optional on others)

A standard differential delivers torque equally to each wheel. In case one wheel loses traction and begins to spin, the differential distributes the rotary speed unequally but with same torque. This can cause the wheel with good traction to slow down or stop while the wheel which lost traction rotates with increased speed. Such a situation can prevent the vehicle from moving.

The limited slip differential provided in the rear axle takes care of such situations. The clutch lock arrangement provided internally, ensures that in case one wheel loses traction and begins to slip, a locking action takes place which prevents differential action and both wheels turn at the same speed.

Thus unnecessary spinning of one wheel is avoided and torque is transmitted to both wheels, thus assisting the vehicle to traverse loose terrain. However during normal driving, the differential action takes place in the same manner as in a standard differential.

1. Four Wheel Drive Operation

In 2-H mode, only the rear two wheels of the vehicle are powered by the engine and the front wheels are merely pushed. By shifting to four wheel drive mode (4H or 4L) the rear as well as the front axles get geared to the engine through transfer case and transmit the engine power to all four wheels. This gives the vehicle increased traction.

In 4H mode, the transmitted engine torque and vehicle speed remain the same as in 2H. However, when you shift to 4L mode engine torque is multiplied and vehicle moves at low speed in the same gears with increased traction. 4L mode is provided for negotiating sharp gradients or driving through loose soil/sand.

2. Shifting from 2H to 4H

Turn the selector knob from 2H to 4H position. 4H indicator on instrument panel will light up. Changing from 2H to 4H can be done at any speed upto 65 km/h (40 mph). No pressing of clutch pedal is required.

3. Shifting from 4H to 2H

Turn the selector knob from 4H to 2H position. 4H indicator on instrument panel will go off. Changing from 4H to 2H can be done at any speed upto 65 km/h (40 mph). No pressing of clutch pedal is required.

Free Wheeling of Front Hub

After shifting from 4H to 2H, for effecting free wheeling of front wheels, direction of vehicle motion needs to be changed. If the vehicle was moving forward in 4H then bring it to halt and engage reverse gear of main gear box. (If it was moving reverse in 4H mode then stop it, and then engage forward gear of main gear box.) After stopping and changing the gear the vehicle must travel in opposite direction for a minimum of three meters, before free wheeling takes place.

4. Shifting from 4H to 4L

Stop the vehicle. Press clutch pedal. Turn the selector knob from 4H to 4L position. 4L indicator light on instrument panel will blink few times and remain on.

5. Shifting from 4L to 4H

Stop the vehicle. Press clutch pedal. Turn the selector knob from 4L to 4H position. 4H indicator light on instrument panel will blink few times and will remain on.

NOTICE

Do not engage four wheel drive mode (4H or 4L) continuously on dry and hard road surface. It can cause expensive damage to the vehicle transmission and the tyres.

Four wheel drive facility is a powerful tool which enables the vehicle to traverse terrain which is otherwise inaccessible to two wheel drive vehicles. However, it must be used judiciously and carefully. Do not take unnecessary risks and attempt the impossible. Familiarise yourself thoroughly with the vehicle and its abilities before attempting serious off road driving.

With ignition 'ON' 4H & 4L indicator lamp on panel should glow for a few seconds only & then go off. Continuous illumination of 4L & 4H lamps indicates electrical fault.

Fuel Economy

- A.** Drive smoothly, accelerate gradually and anticipate stops.
- B.** Best fuel consumption is achieved at low engine speeds, the highest possible gear without labouring the engine.
- C.** Driving with accelerator pedal fully depressed means using excessive fuel.

- D.** Do not allow engine to labour. Change to lower gear when engine no longer runs smoothly.
 - E.** If possible, do not idle the engine for more than 2 minutes. Switch off the engine.
 - F.** Do not ride the clutch OR brake pedal while driving. Do not use clutch pedal as foot rest.
 - G*.** When changing from 4H/4L to 2H of transfer case, 2H free wheeling should be done.
If 2H free wheeling is not done the hub locks of front hub remain locked causing unnecessary rotation of front drive components and this consumes more fuel and causes wear and tear of front axle components.
 - H.** Depending on traffic conditions, a constant speed should be maintained.
The vehicle uses more fuel, every time you speed up or slow down.
 - I.** Hard braking, abrupt cornering and rapid acceleration use more fuel. Avoid these.
 - J.** Do not carry unnecessary weight in the vehicle.
 - K.** Maintain moderate speed limits, while driving.
 - L.** Always ensure that front wheel alignment is proper.
- (*For 4 WD model only.)

Driving on Snowy or Icy Roads

Set the selector knob to 4H position. Gently release the clutch and apply the accelerator for a smooth start and to avoid wheel spin.

CAUTION

Use of snow tyres and / or tyre chain is recommended.

Maintain a safe distance between vehicles to avoid sudden braking and slow down by shifting down the gears.

Avoid sudden acceleration, braking or turning. Such sharp manoeuvres can cause loss of traction and thereby loss of vehicle control.

Driving on Sandy or Muddy Roads

In case the traction on the wheels is sufficient, you may be able to proceed in 4H mode. However in case change in road conditions are anticipated, it is better to select the 4L mode. Shift the selector knob to 4L position by following the correct procedure and proceed in the normal manner. Your vehicle will move at a slower pace with higher engine RPM in the same gear because of the 4L mode. To match your power and speed requirements, you can shift up in any of the 5 forward gears or the reverse gear.

NOTICE

You may choose to reduce the tyre pressure marginally for additional grip on loose surfaces, though with a slight loss of ground clearance.

- Try to maintain a constant engine speed and avoid sudden acceleration which can cause wheel spin and loss of traction, possibly leading to bogging down of the vehicle.
- If the vehicle gets stuck in loose sand, do not keep on accelerating as the wheel spin will only result in the wheels sinking deeper.
- The extent of muddy / sandy conditions and the traction available is difficult to judge and the vehicle can get bogged down deeply. Operation should be done at slow speed only. If possible, get down and check the path conditions before proceeding.

Driving Through Water

- Never venture to drive through water when it flows over guard stones.
- Engine may get seriously damaged if attempted to cross over through deep water.
- If at all the situation demands that you have to drive through water then;
 - Keep engine in fast idling and crawl the vehicle in low gear.
 - After driving through water apply brakes several times to dry liners and to regain original braking.

Do not attempt to start the engine if vehicle gets flooded due to water.

- Tow the vehicle to a safe place.
- Take the vehicle to nearest AUTHORISED Workshop to check entry of water in cylinders.
- It will also be necessary to replace lubricants of engine, gearbox, transfer case, front axle and rear axle if water has entered.
- Get the starter and alternator checked.

Driving on a Rainy Day

- Check brakes, steering and windows.
- Check tyres for wear and tyre pressure.
- Check wiper blades for proper functioning.
- Avoid harsh braking and sharp turns. It may cause loss of control and lead to a skid.
- For slowing down, shift to lower gears and brake gently.
- Keep lights ON if visibility is poor.

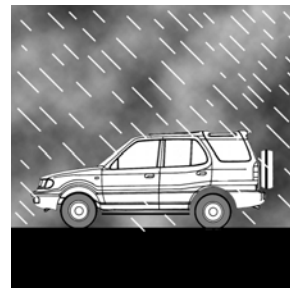
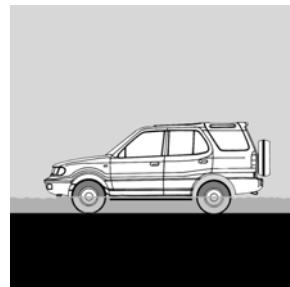

Night Driving

- Dip the head lamp for oncoming traffic during night driving.
- Maintain a speed such that you can stop within illuminated distance of head lamps.
- Use head lamp main/dip beam to alert other road users on turns/cross roads etc.
- Use side indicators for lane change or turning.
- Put on hazard warning switch in case of hazardous parking or if your vehicle is disabled to warn the passing traffic.



Climbing Sharp Gradients on Loose Surfaces

- Select the 4L mode, start off smoothly in any suitable gear. Apply power smoothly so that there is no loss of traction by over-revving of the engine.
- Choose as smooth a slope as possible and select the appropriate gear so that gear changing in the middle of the climb is not required.
Changing gears in the middle of the climb can cause loss of momentum and engine stalling. Shifting to lower gear has to be done cautiously to avoid loss of traction.
- Under no conditions should the vehicle be moved diagonally across a hill. The danger is in loss of traction and sideways slippage, possibly resulting in tipping over. If unavoidable, choose as mild an angle as possible and keep the vehicle moving.
- If the wheels start to slip within few feet of the end of the climb, motion can be maintained by swinging the steered wheels left and right, thereby providing increased grip.
- If the vehicle stalls or losses headway while climbing a steep hill, make a quick shift to reverse and allow the vehicle to move back with the control of engine compression.

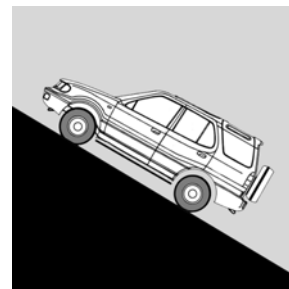

Descending Sharp Gradients

- Select the 4L mode and depending on the severity of the gradient, shift into appropriate gear. Use engine braking judiciously without over-revving the engine.
- Brake application under such situations should be done very smoothly to avoid loss of control.

Select appropriate gear so that gear changing or clutch disengagement is not involved while descending the gradient.

Towing the Vehicle

- For towing the vehicle, the best way is to use a recovery van.
- Alternatively use a rigid tow bar.
- Avoid using flexible cable or rope as your vehicle may crash into towing vehicle when it stops suddenly.
- Switch 'ON' Hazard warning switch to warn the other road users.
- Keep the engine in idling so that power steering assistance is available. This will also built the vacuum for the brakes.
- In case of brake failure, use parking brake to control the vehicle.

Roof Rail

The provision for mounting roof racks is made on the vehicle. This can be done with the help of roof and roof header mouldings provided above the rear fixed glass. The max. load on this including roof rack load should not exceed 100 kg.

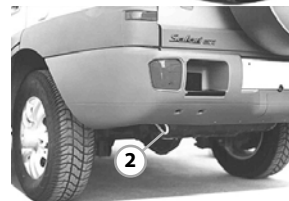
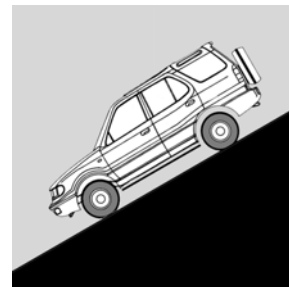

1. Front Tow Hook
2. Rear Tow Hook

DRIVING SAFETY

Seat Belt

Seat-belts are life saving equipment, use of seat-belt reduces the chance of injury and severity of injury in case of an accident. It is strongly recommended that all the car occupants should always wear seat-belt, while car is in motion.

WARNING

If the vehicle is fitted with air bags, the air bag is a supplementary restraint system and can only provide intended protection when the seat-belts are worn. For maximum safety in any collision a seat-belt must be worn.

Influence of Alcohol

Avoid driving under the influences of alcohol or drugs. Alcohol and drugs will severely impair your

control of the vehicle and increase the risk of injury yourself and others.



mobile phones

Avoid using mobile phones while driving a car. This could divert your attention from the road and result in an accident.

Fatigue 'Rest Revive survive'

Do not attempt driving when you feel tired, sleepy long distance driving can tire you very much and fatigue can dull your reflexes and judgment. Take a brake and get refreshed at intervals.

SAFETY CHECKS

Windshield/wiper/windshield washer

Always keep windshield glass clean to avoid any distraction in visibility. Ensure proper working of wipers and condition of wiper blade. Ensure that windshield washer reservoir is full. Do not operate wiper alone when the windshield glass is dry this would damage the windshield.

Headlights

Keep headlight lenses clean. Check for operation of headlamps in both high/low beam condition. Check for correct focusing of headlamps. Use only recommended type of bulbs. Do not use the high beam unless it is inevitable. Its dazzle may glare the driver of the oncoming car the condition thus causing an accident.

Side indicators / Hazard warning

Ensure that all side indicators/hazard warning lights are always in working condition and they are used when required.

Horn

Ensure the horn is working properly. Horn provides safety to other road users by alerting your presence.

Brakes

Ensure brakes are working properly. Check brake fluid level in reservoir. Don not drive the car when brake warning lamp is 'ON'.

Tyres

Check the condition of tyres for any abnormalities. Maintain correct tyre pressure, it is very important

particularly when subjected to extreme condition, such as high speed, high load and high outside temperature. Do not use worn or bald tyres on the front wheels.

First Aid Kit

First aid kit is provided in your vehicle. This is for use in case of minor injuries. It is to be regularly checked for any disintegration and should be updated regularly.

Advance Warning Triangle

There is an advanced warning triangle provided along with your vehicle. In case there is a breakdown and the vehicle is parked at the side of the road, then the triangle is to be kept as per instructions given below :

Remove advance warning triangle from case and assemble.

Place the triangle on the road behind the vehicle when it stranded on the road. The triangle must be at least 5 meters behind the vehicle in the same lane of traffic.

Increase the distance to 150 meters on a highway or if a bad/hill top obscures the view.



This section give information regarding recommendations of fuel & oils to be used on TATA Safari Vehicles. Use only these fuel & oils on your vehicle to avoid damage to vital systems & components.

- **Fuel**
- **Lubricants**
- **Coolants**
- **Recommended oils & lubricants**

Fuel

High speed diesel conforming to IS 1460 or EN 590 or equivalent is recommended to be used as fuel.

NOTE : Do not use premium diesel available in the market.

At very low temperatures fluidity of diesel may become insufficient due to paraffin separation. It is therefore, necessary to mix supplementary fuel with summer or winter grade diesel. The supplementary fuel to be used is kerosene or aviation turbine fuel.

Ratios for mixing of supplementary fuel and diesel are shown in table:

Ambient temperature upto Deg C.	Percentage	
	Summer Grade diesel	Suppl. fuel
upto 0	100	0
0 to -10	70	30
-10 to -15	50	50

Ambient temperature upto Deg C.	Percentage	
	Winter Grade diesel	Suppl. fuel
upto -15	100	0
-15 to -20	70	30
-20 and below	50	50

Care should be taken that diesel and supplementary fuel are thoroughly mixed before filling.

Recommended Fuel Specification for engines to be added.

	Parameter	Unit	BS III	BS IV
1	Cetane Number (min)	CN	51	51
2	Sulphur content	mg/kg	350	50
3	Lubricity (HFRR)	micon	460	460

Lubricants and Oils

Recommended lubricants conform to the following specifications :

- 1. Engine oil** - API-CH4 + MB 228.3 or higher grade engine oil
- 2. Gear Box oil** - 75W90 GL-4
- 3. Power Steering and Transfer Case** - ATF Type A, Suffix A
- 4. Rear & Front axle** - M/Grade oil SAE 85W 140 GL5 Angolmol AG043 oil
* Friction modifier 40819 (2-5%) to be added to oil for Limited Slip Differential
- 5. Chassis and wheel bearing** - SS6805 bearing grease

Please use only recommended grades for good performance.

DO NOT mix grease of different brands and optional grades. Replace old grease completely.

The oil change periods recommended in maintenance schedule should be adhered to.

Engine

Qty : 7.5 Litres

Recommended grades of engine oil for range of ambient temperature :

Ambient Temperature °C	Engine Oil Grade
- 5 and above	SAE 15W/40
- 10 to 0	SAE 5W30
- 20 and -10	SAE 0W30

Front live axle and rear axle oil (Spicer axles)

Use Multigrade oil SAE 85W 140 Angolmol A6043 oil

Capacity : **For Rear axle - 2.2 litres**
 For Front axle - 1.2 litres

Gear Box oil :

Qty : 1.6 Litres

75W90, (Synthetic oil GL4)

Transfer case oil :

Qty : 1.2 Litres

Recommended lubricants should confirm to General Motors, ATF A specification

Hub bearing grease

Use lithium base multipurpose grease -

Quantity :
92 gms per hub. (Front axles 4X4)
47 gms per hub. (Front axles 4X2)
25 gms per hub. (Rear)

Brake and Clutch Fluid

Brake fluid confirming to SAEJ 1703, DOT 4 is recommended.

Spicer propeller shaft

Lubricant slip joint with NLGI-2 grade grease.

Coolants

Qty : Approx. 9-10 Litres

Presence of dirt in coolant chokes up passages in radiator, cylinder head and crankcase, thereby causing overheating of engine.

To prevent rust formation and freezing of coolant inside the passages of radiator, crankcase and cylinder head use premixed coolant as recommended.

It is recommended that the entire cooling system should be drained and filled with fresh premixed coolant.

Engine coolant antifreeze coolant as per class II, JIS K2234

Windscreen Washer Antifrost

Make	-	Antifrost- K
Concentration	-	1 : 5 For 0°C
		1 : 1 For 10°C
		2 : 5 For 16°C
		1 : 0 For 37°C

FUEL, LUBRICANTS & COOLANTS

BRANDED LUBRICANTS, COOLANTS & ADHESIVES

PLEASE USE ONLY FOLLOWING GENUINE OILS, COOLANTS, LUBRICANTS, ANTI RUST & SOUND DEADENING COATS, WINDSCREEN SEALANT, ADHESIVES & FUEL ADDITIVES BRANDED BY TATA MOTORS FOR OPTIMUM PERFORMANCE OF YOUR TATA Safari DICOR...

ITEM	COMPANY	BRAND	QTY
ENGINE OIL	CASTROL HPCL Exxon Mobil	Castrol GTX (Diesel) HP Dieselino (T) MOBIL Super 1000 TM	7.5 Litres (Max.) 5.5 Litres (Min.)
COOLANT	SUNSTAR HPCL CASTROL	Golden Cruiser Premium 1400 M HP Thanda Raja P Radicool	Approx 9-10 Litres
GEAR BOX (G-76)	HPCL CASTROL	HP Gear Oil XP 75W90 Castrol Syntro 75W90 GL4	1.6 Litres
TRANSFERCASE	HPCL CASTROL	HP-Automatic Transmission Fluid Type A Castrol Transpower TQ	1.2 Litres
POWER STEERING OIL	HPCL CASTROL	HP-ATF Dex II Castrol TQD	1.4 Litres
REAR AXLE, LIVE FRONT AXLE,	HPCL CASTROL	HP AXLE OIL 85W140 Castrol Long Drain 85W140	2.2 (Rear) 1.2 (Front)
BRAKE / CLUTCH FLUID	HP CL CASTROL	Super Duty Brake Fluid DOT - 4 Castrol Response Brake Fluid DOT-4	As required

VEHICLE SPECIFICATIONS

This section give information on specification of various aggregates fitted on TATA SAFARI vehicles.

- **Engine**
- **Clutch**
- **Gear box**
- **Transfer case**
- **Rear axle**
- **Front axle**
- **Steering**
- **Brakes**
- **Frame**
- **Suspension**
- **Wheels & Tyres**
- **Fuel tank**
- **Body**
- **Electrical system**
- **Performance**
- **Dimensions**
- **Passenger capacity**
- **Luggage space**
- **Weights**

1.0 ENGINE :

Model	:	TATA 2.2 L DICOR
Type	:	16 valve, Water cooled, Direct injection, commonrail , Turbo-charged, intercooled Diesel Engine.
No. of cylinders	:	4 inline
Bore/Stroke	:	85 mm x 96 mm
Capacity	:	2179 cc
Max. engine output	:	103 kw at 4000 rpm
Max. Torque	:	320Nmat 1700-2700 rpm as per CMVR / TAP-115/116
Firing order	:	1-3-4-2
Engine oil capacity	:	Max.7.5 litres / Min.5.5 litres

2.0 CLUTCH:

CLUTCH	:	Single plate dry friction diaphragm type
Outside diameter of clutch lining	:	240 mm
Friction area	:	452 sq.cm. (approx.)

3.0 GEAR BOX :

Model	:	G-76-5/4.1 with overdrive
Type	:	Synchromesh on all gears
No. of gears	:	5 Forward 1 Reverse
Gear ratios	:	1st 4.10
		2nd 2.22
		3rd 1.37
		4th 1.00
		5th 0.77 / 0.73
		Rev. 3.75

4.0 TRANSFER CASE :

(for 4x4 configuration) : From M/s Borg Warner
ECU control Electrical shift
shifting arrangement
mounted on the gear box.

Drive Options : 4X2 High Ratio 1:1
 4x4 High Ratio 1:1
 4x4 Low Ratio 1:2.48

5.0 REAR AXLE :

: Single reduction salisbury
type rear axle with hypoid
gears and semi-floating axle
with limited slip differential
for 4 x 4, without limited slip
differential for 4 x 2

Ratio : 4.1 (41 / 10)

6.0 FRONT AXLE :

a) For 4x4 : Independently suspended
with automatic hub locks.
Ratio 4.1 (41 / 10)

b) For 4x2 : Independently suspended

7.0 STEERING :

Type : Power steering
Ratio : 18.9 :1
Steering Wheel : 380 mm dia with tilt
mechanism for adjusting
height and collapsible
column.

8.0 BRAKES :

Service Brakes : Vacuum assisted independent
hydraulic brakes on front and
rear through tandem master
cylinder & tandem booster.
Camshaft driven vacuum
pump.
Front Brake : 302 mm dia ventilated
disc brake with twinpot
caliper.
Rear Brake : 295 mm dia drum brake
with auto adjuster,
Load conscious pressure : Provided for rear brakes
reducing valve remote by No 'LCRV' for version
pars valve with ABS

Parking Brake : Lever type, Console mounted,
Cable operated mechanical
linkages acting on rear wheels.

Anti-lock Braking System (ABS) if fitted

System : ABS 8.1
Type : 4 channel, 4 wheel speed sensor
integrated ABS
Control : Microprocessor based ECU

9.0 FRAME :

Frame : Ladder type cranked frame with
boxed section long members
and welded cross members
Depth : 110 mm (max.)
Width : 60mm

10.0 SUSPENSION :

Front : Double wishbone type with
Torsion bar springs.
Rear : Coil spring type 5 link suspension
Shock : Hydraulic double acting
Absorber : telescopic type at front & rear.
Antiroll bar : At both front & rear.

11.0 WHEELS & TYRES :

Tyres : 235/70 R 16
Passenger Radial tubeless
Wheels rims : 6.5 J x 16 Stylised Steel rims
6.5 J x 16 Alloy wheel rims
No. of wheels : Front 2, Rear 2, Spare -1

12.0 FUEL TANK :

Capacity : 65 Litres

13.0 BODY :

Type : Normal control all steel
shell with five doors.

14.0 ELECTRICAL SYSTEM :

System Voltage : 12 Volts (-ve earth)
Alternator Capacity : 120 / 125 Amps
Battery : 12 V, MF 70 Z
Capacity : 80 A/h, 20 Hr Rate

15.0 PERFORMANCE :

Max. speed	:	160 kmph
Max. gradeability	:	78% (4x4 mode)
at rated GVW	:	50% (4x2 mode)

16.0 MAIN CHASSIS DIMENSIONS (in mm) :

AS PER ISO : 612 IN MM (Nominal)

Wheel base	:	2650
Track front	:	1500
Track rear	:	1470
Front Overhang	:	945
Rear Overhang	:	1055 over rear bumper
Overall length	:	4650 over rear bumper
Max. width	:	1918 - with foot steps
overall height	:	1925 (unladen)
Min. turning circle dia	:	12 m
Min. clearance circle dia	:	13 m
Ground clearance	:	205 mm

17.0 PASSENGER :

Capacity	:	7 Seater (6 + Driver)
		Front Seat - Driver + 1
		Middle Seat - 3
		Rear Seat - 1+1 (Jump Seats)

18.0 LUGGAGE SPACE :

Net inside loading	:	1000 mm wide X 800 mm space long (with 4 passengers + Driver)
--------------------	---	---

19.0 WEIGHTS (Kg) :

		4 x 4	4 x 2
Complete vehicle kerb weight as per ISO : 1176 (with spare wheel and tools)		2170	2040
Gross Vehicle Wt.		2780	2650
Max. Permissible FAW		1280	1200
Max. Permissible RAW		1580	1540
Kerb Weight	Front	1130	1030
	Rear	1040	1010

Your TATA SAFARI is designed to give you long trouble free service for thousands of kilometres/miles. However with proper maintenance care you can get optimum performance from your vehicle. We have indicated some of the important maintenance operations to be carried out on the vehicle. Please read the procedure carefully and get it attended at Authorised Workshop.

- **Engine Compartment**
- **Air filter**
- **Cooling system**
- **Engine oil & oil filter**
- **Changing fuel filter**
- **Changing gear box oil**
- **Changing transfer case oil**
- **Changing front axle & rear axle oil**
- **Head lamp & head lamp focus adjustment**
- **Clutch & brake fluid**
- **Power steering**
- **LCRV (if fitted)**
- **Battery**
- **Starting the engine with jump leads**
- **Wheels & tyres**
- **Vehicle care**
- **Fuses & Relays**
- **Catalytic Converter**
- **EGR system**
- **Turbocharger**
- **Air Conditioning**
- **Belts tension**

ENGINE COMPARTMENT

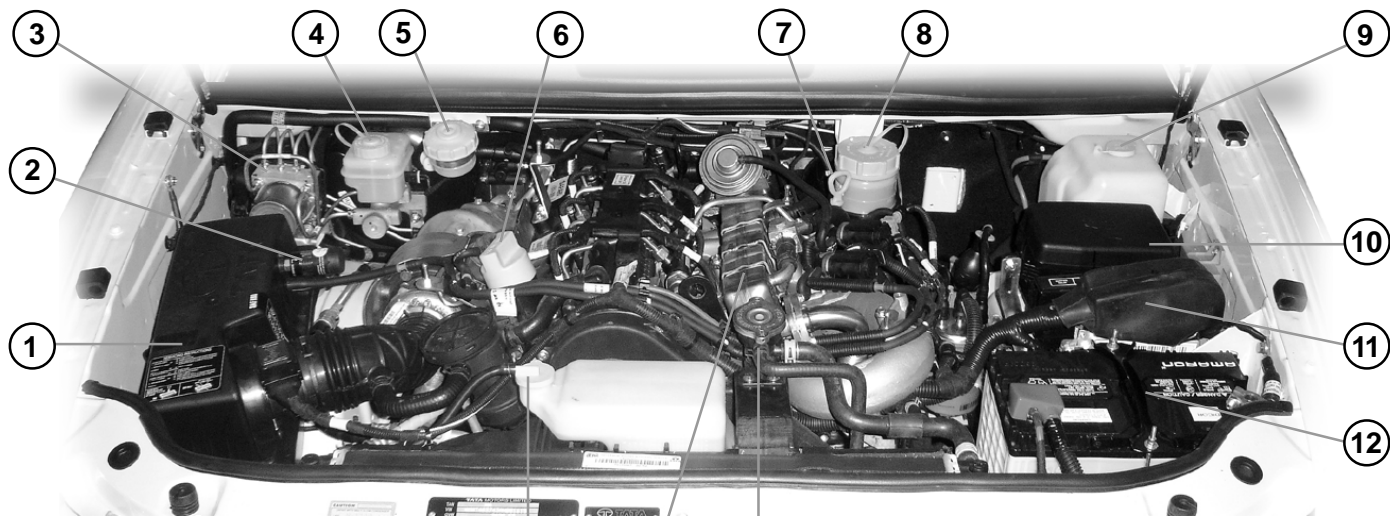

- | | | |
|--------------------------|-----------------------------------|--------------------------------------|
| 1. Air Filter | 2. Service Indicator | 3. ABS Hydraulic Modulator |
| 4. Brake Fluid container | 5. Clutch fluid container | 6. Engine Oil filler cap |
| 7. Dip Stick | 8. Power Steering Fluid container | 9. Windshield Washer Fluid container |
| 10. Fuses & Relays Box | 11. EMS- ECU | 12. Battery |
| 13. Radiator Cap | 14. EGR Cooler (Only in BS-IV) | 15. Coolant Tank |

Air Filter

The air filter element should be cleaned as per service schedule . Replace the air filter element with a new one when the service indicator shows red band even after cleaning in vehicle operations. Always use genuine air filter element.

Replacement of Air Filter Element

- a) Disconnect air filter from hose. Unscrew top cover of the air filter.
- b) Remove the cover of the air filter.
- c) Remove the air filter element.
- d) Clean the air filter element with pressurised air. Do not tap or hammer the element on ground.
- e) Check element for puncture or pin holes by light source.
- f) If found OK install paper filter element. Fit the cover and tighten air filter screws at the place.
- g) Clean the hose connecting the air filter to turbocharger pipe.

Reset the indicator by pressing the rubber cap, red band will disappear from Service Indicator.

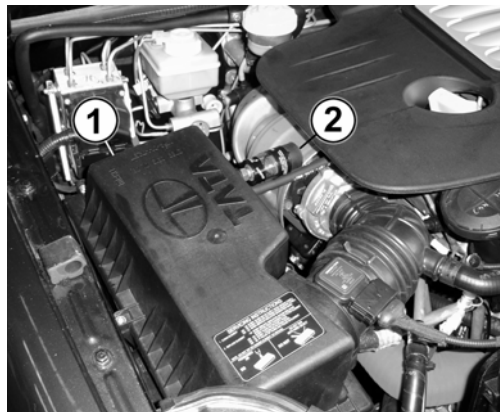

1. Service Indicator 2. Air filter

Engine Cooling System

If engine overheating occurs, there could be a fault in the cooling system which may be on account of :

1. Less coolant in the cooling system or dirt/scale having accumulated inside cooling water passages especially in the radiator core.
2. Choking of radiator passages due to foreign material or damages.
3. Defective thermostat.
4. Defective coolant temperature sensor.
5. Non operation of electrically operated fans (Controlled by ECU).
6. Coolant leakage.
7. Radiator cap not sealing properly.
8. A.C. condenser fan not working
9. Excessive refrigerant charging in the A.C. system.
10. No communication between auxiliary tank and radiator.

Prevention of Rust Formation

To prevent rust formation in the radiator use premixed recommended anti-freeze coolant. This is sufficient to operate the vehicle upto -40°C.

The coolant filling Procedure:

It is recommended that the refilling of the engine coolant should be carried out at authorized service centre

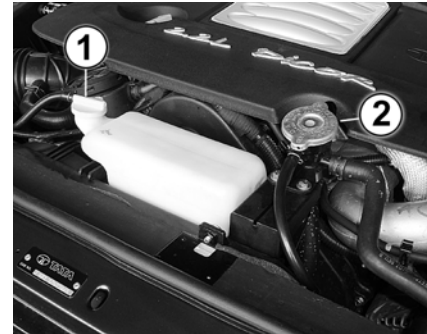

1. Auxiliary Tank 2. Radiator Pressure Cap

1. Air evacuation and coolant filling (Vacuum filling) Method:

The coolant refilling in the system is recommended to be carried out through air evacuation and coolant filling method for quick filling.

1. Allow the engine to cool up to ambient temperature.
2. Keep cabin heater valve (if applicable) at "ON" position throughout the coolant refilling.
3. The complete cooling system should be drained (old coolant) before refilling the system.
 - a. Remove radiator pressure cap *and bleeding screw at EGR cooler outlet (BSIV engine)*
 - b. Drain the coolant from engine through by removing

thermostat and thermostat housing cover. Drain coolant from radiator through the radiator drain hole.

c. Pour fresh water through the filler neck up to top and again drain the water through the drain holes.

This will ensure removal of the old coolant from the system

d. After flushing out water, secure the drain plug on radiator. Assemble thermostat and thermostat housing cover with new gasket. *Refit the bleeding screw at EGR cooler outlet with new sealing washer (BSIV engine)*

e. Drain the auxiliary tank and refit the hoses.

4. Take the recommended coolant and water in 1:1 proportion
5. Carry out air evacuation and coolant filling on machine (Vacuum filling)

(The machine setting to be done as follows, Quantity to be filled: 6.1L (BSIII) and 6.4L (BSIV engine) approx, back pressure: 1.7 bar)

6. Fill the coolant in auxiliary tank up to "FIRST FILL / REFILL" mark

2. Manual Coolant refilling:

If the air evacuation and coolant filling (vacuum filling) system is not available, then alternate procedure is as mentioned below.

1. Follow sr. no 1 to 4 indicated in Air evacuation and coolant filling (Vacuum filling) procedure.
2. Refill the coolant (coolant and water as per recommendation) through radiator filler neck. Remove the bleeding screw at EGR cooler outlet (BSIV)

3. When coolant level comes up to radiator filler neck / bleeding screw, wait and allow air bubbles to escape from the system for 2 to 5 min. Top up coolant in radiator filler neck when level drops.
4. Refit the bleeding screw with new sealing washer (for BSIV)
5. Fill the coolant in the auxiliary tank up to "FIRST FILL / REFILL" mark.
6. Start the engine and run at idle for 10 min. with open radiator filler neck. Allow air to escape from the system. Top up coolant slowly in the radiator filler neck while idling.
7. Stop the engine and allow air bubbles to escape from the system. Top up coolant through radiator filler neck. Secure the radiator pressure cap on radiator filler neck.
8. Start the engine and run in stationary condition at 2200 to 2500 rpm till thermostat opens and continue to run for 5 minutes. (The radiator fans coming on is the indication of opening the thermostat)
9. Stop the engine and allow it to cool. Open the radiator pressure cap & top up coolant in radiator filler neck. Secure the radiator pressure cap on the radiator filler neck.
10. Refill the coolant in the auxiliary tank till "first fill / Refill" level mark.
11. The coolant refilling is complete now.
12. Ensure that there are no leakages in the complete system.

Changing of Engine Oil and Oil Filter

Change the oil and oil filter at specified service intervals. (Engine oil and oil filter may be changed earlier inline with recommendation given for additional maintenance schedule under severe driving condition)

Changing of oil and oil filter requires access from underneath the vehicle. Vehicle should be raised on a hydraulic lift of a service station or should be on a service pit.

1. Run the engine until it reaches normal operating temperature. Then shut it off.
 2. Remove oil sump guard.
 3. Open the bonnet and remove engine oil filler cap. Remove the drain plug of the oil sump from the bottom of the engine. Drain the oil into an appropriate container.
 4. Remove the oil filter with the help of special wrench. The removed oil filter should not be reused and hence should be destroyed to avoid recycling of the same. Used filter and oil should be disposed in compliance with the current legislation.
 5. Ensure cooler is tightened to its position.
 6. Smear a little fresh engine oil on rubber gasket of new engine oil filter. Hand tighten the engine oil filter fully and further 3/4 turn with special tool.
- Do not over tighten engine oil filter as this may damage oil filter and oil may leak out.
7. Before filling in fresh oil in the engine, clean the drain plug.

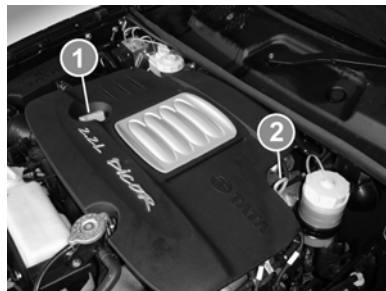

1. Engine Oil Filling Neck
2. Dip Stick

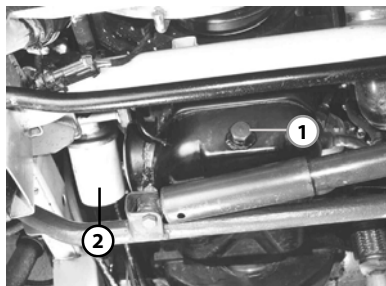

1. Oil Sump Drain Plug
2. Engine Oil Filter

6. Refit the drain plug using a new sealing washer. Tighten drain plug to 5 mkg. torque.
7. Fill, recommended quantity of fresh engine oil in the crank case and secure the oil filler cap in its place.
8. Start the engine and run for a few minutes. The engine oil pressure indicator lamp should go 'off' after starting the engine.
9. Check for engine oil leakages.
10. Stop the engine and recheck engine oil level after a few minutes. If necessary add oil to bring the level to the upper mark on the dipstick.

NOTICE

Use of reclaimed oil is not recommended

Priming Pump

Priming pump is used for priming the fuel manually after overhauling of the engine or after refitment of fuel lines. Pump the fuel by means of priming pump until all air in the fuel line is removed. Before cranking the engine ensure that there is no air in the fuel system.

NOTICE

Please do not loosen/remove high pressure pipes and injectors for air bleeding in the fuel.

Fuel & Filter Draining

Loosen drain plugs by 1-2 turn and drain out water and other sediments from fuel filter bowls depending on operating conditions to ensure that no water is allowed to enter the fuel system.

Sedimenter Water Draining

Water sedimenter is located near fuel tank at rear left hand side of the vehicle.

Loosen drain plug by 1-2 turns and drain out water and other sediments from sedimenter when water level indicator lamp glows in instrument cluster to ensure that no water is allowed to enter the fuel system.

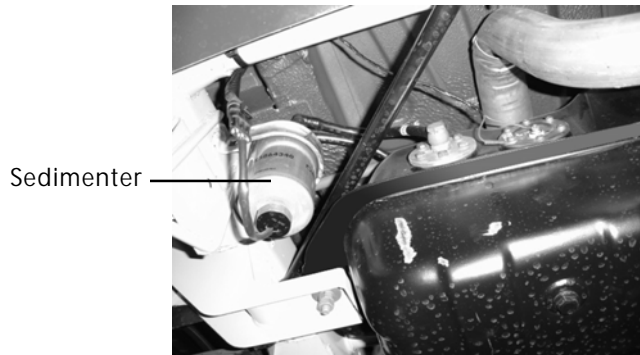

Gear Box Oil

Checking of Oil Level

1. Clean the oil level plug and surrounding area.
2. Remove the oil level plug and check whether oil is dripping out. Oil level must not be below the filler plug. Add oil to bring it to the level.
3. Tighten oil level plug to 2-3 mkg. torque.

Changing Oil in Gear Box

1. Let the engine idle for about 5 min. in neutral, so that the gear box oil is warmed up.
2. Clean the oil level plug, drain plug and surrounding area.
3. Place a container under gear box to collect the oil.
4. Remove the drain plug and let the oil drain out.
5. Also remove the oil level plug.
6. Tighten the oil drain plug and fill new recommended oil through oil level plug and tighten the oil drain plug oil level plug to 2-3 mkg. torque.

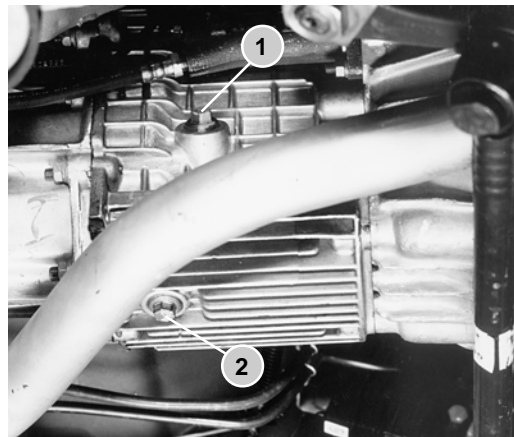

1. Gear Box Oil Filler Plug / Level Plug
2. Gear Box Drain Plug

Checking Oil Level of Transfer Case

NOTICE

Before checking or removing the oil, warming up of the transfer case is necessary. This should be done by driving the vehicle for some time in 4x4 mode.

Checking of Oil levels

1. Clean the oil level plug and surrounding area.
2. Remove the oil level plug and check whether oil is dripping out.
3. If oil is not dripping out, oil level must be below the required level. Add oil to bring it to the level when it starts dripping out.
4. Tighten oil level plug. Tightening torque of oil level plug is 2 to 3 mkg.

Changing of Transfer Case Oil

1. Clean the oil level plug, drain plug and surrounding area.
2. Place a container to collect oil, under transfer case.
3. Remove the drain plug and let the oil drain out.
4. Remove the oil level plug.
5. Tighten oil drain plug and fill new recommended oil through oil level plug, till it begins to drip out.
6. Tighten oil level plug. Tightening torque of oil drain plug is 2 to 3 mkg.

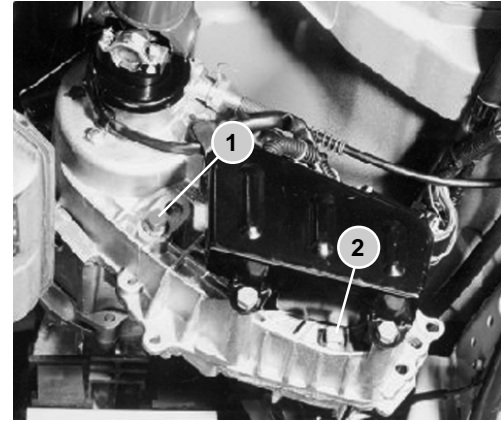

1. Transfer case Oil Filler Plug / Level Plug
2. Transfer case Oil Drain Plug

Checking Oil Level in Front/Rear Axle

1. Clean the oil level plug and surrounding area.
2. Remove the oil level plug and check whether oil is dripping out. Oil level must be below the required level. Add oil to bring it to the level, when it starts dripping out.
3. Tighten oil level plug to 2 to 3 mkg. torque.

Changing Oil in Front Axle/Rear Axle

1. Clean the oil level plug, drain plug and surrounding area.
2. Place a container under Front/Rear axle to collect the oil.
3. Remove the drain plug and let the oil drain out.
4. Also remove the oil level plug.
5. Tighten the oil drain plug and fill new recommended oil through oil level plug till it begin to drip.
6. Tighten oil drain and oil level plugs to 2 to 3 mkg. torque.

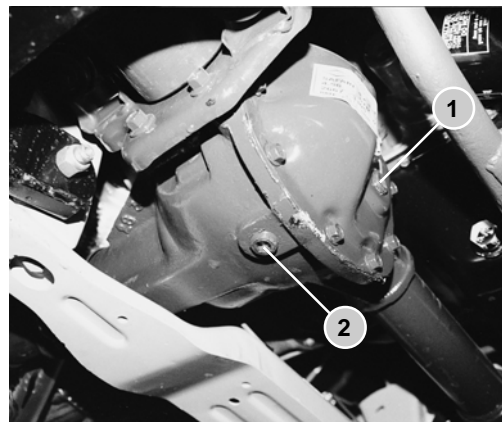

1. Front Axle Oil Filler Plug / Level Plug
2. Front Axle Oil Drain Plug

Head Lamps

Your car's head lamps have H4 type halogen bulbs with twin filaments, the "High beam" for illuminating the road for long distances and the "Low beam" for short distance visibility.

The head lamps must be aligned properly for maximum road illumination and reduced glare for oncoming traffic. The alignment of head lamp beams should be checked periodically.

Adjusting Head Lamp Focus with the Help of Screen:

Philips head screws are provided for horizontal and vertical adjustments of your car's headlamps. This should be done at the Authorised Service outlets. Ensure that the Headlamp Levelling switch on the dashboard is set to Zero position before readjustment and the car must free from any loads (passengers / Luggage).



Head Lamp

Fog Lamp

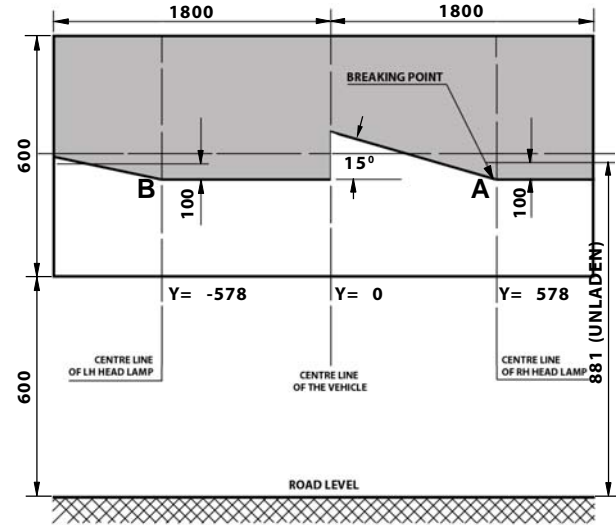

Adjusting Head Lamp Focus with the Help of Screen

Head Lamp Bulb Replacement

Raise the bonnet of the vehicle. Unscrew & pull out the rear protective cover. Pull out the cable socket from the bulb. Remove locking lever holding the bulb and remove the bulb.

Install new bulb, properly locating it in the housing. Fit back the locking lever cable socket and rubber cap.

Repeat the same procedure for pencil beam lamp.

Realign Head Lamp after Replacing Bulb

Do not clean or touch the reflector as it will damage the mirror finish of the surface.

Your vehicle has halogen head lamp bulb and pencil beam bulb one each on each side. When replacing, handle it by steel base. Protect the glass from contact with your skin or hard object. If you touch glass, clean it with denatured alcohol and clean cloth.

NOTICE

Halogen head lamp bulbs get very hot when lit. Oil perspiration or a scratch on the glass can cause the bulb to overheat and shatter.

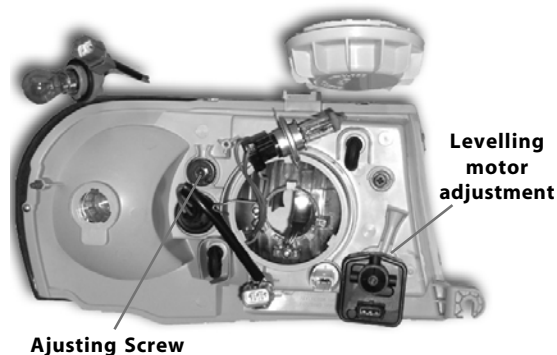

Clutch Fluid

The Tata Safari vehicle is equipped with a diaphragm type clutch Which is hydraulically actuated.

The level of clutch fluid in clutch fluid container should be in between Min. and Max. marks. If it is not, then add clutch fluid.

In case of spongy or hard clutch pedal, please contact the nearest Authorised Workshop and get the defect rectified.

Brake Fluid

Check the level of Brake fluid in Brake fluid container.

It should be in between Min. and Mix. marks.

If it is not, then add brake fluid.

In case of spongy or hard pedal or low brake efficiency, please contact the nearest Authorised Workshop and get the defect rectified.

Power Steering Fluid

Power steering is fitted for lighter steering effect and easy manoeuverability. The system consists of steering gear box, hydraulic pump and hydraulic tank suitably connected by piping. Pump drive is though 'V' belt from engine. Power assistance is available during normal operating conditions. In case of failure in hydraulic system, the steering can be operated mechanically with increased steering effort for bringing the vehicle to Authorised Workshop.

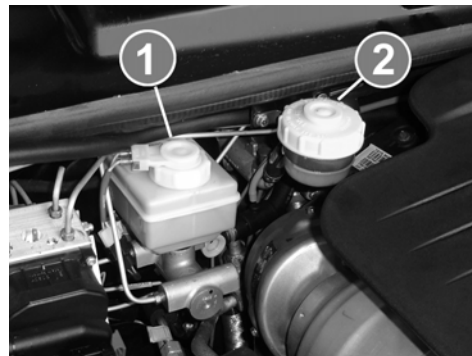

1. Brake Fluid Container
2. Clutch Fluid Container



Power Steering Fluid Container

Procedure for Oil Filling and Bleeding of Power Steering (Ensure that Power Steering fluid reservoir is totally clean before starting the work)

1. Fill the reservoir nearly full. Crank the engine for 10 seconds without allowing it to start (if possible). If engine does start, shut the engine immediately. Check & refill the reservoir repeat atleast three times, each time checking & refilling the reservoir.
2. Check for leakage in the system and if noticed take corrective action.
3. Start the engine and steer the vehicle from full left to full right turns 3-4 times.
4. Add fluid if necessary to maintain the level upto filter top.

NOTICE

Do not force the wheel against lock position either extreme left or right. The power steering pump may get damaged. Hold it lightly.

5. When the engine is at steady speed, check for bubble or foaming in the oil. If present it indicates that air is getting sucked into the systems. Check the suction line/fittings and correct if necessary.

6. Once the system is bled properly and free from foaming there should not be any appreciable change in oil level in the reservoir, when the engine is started or stopped repeatedly.
7. Now the system is ready for driving. Final oil level should be at 'H' mark on dip stick.

NOTICE

- * Do not allow fluid level to drop significantly or run out of the reservoir during the above operation. This may induce air to the system.
- * Do not start the engine without oil in the power steering system. This will result in serious damage to the pump. In case of emergency disconnect the pump belt and then start the engine.
- * Always use recommended oil from closed containers. Any dirty oil poured in the system will result in damage to pump and gear box.

**Load Conscious Pressure Reducing Valve (If fitted)
(Not applicable in ABS system)**

A load conscious pressure reducing valve eliminates the possibility of rear wheels from locking and achieves optimum braking in any load condition of the vehicle.

The valve, is fitted on RH long member connecting it to rear axle through its link and control spring.

If any, alteration is done in rear suspension, the performance of this valve will be impaired.

ECU :

DICOR engine common rail system consists of ECU, sensors and actuators. The Electronic control unit (ECU) is a 32 bit microprocessor which controls the injection parameters as well as some of the vehicle related outputs. The ECU receives input from various sensors located on the engine and the vehicle to decide the injected quantity and injection timing best suited for the engine to work with maximum efficiency and safety. ECU is fitted inside the engine compartment.

⚠ CAUTIONS

- **DO NOT** wash engine compartment with high pressure water
- **DO NOT** tamper with ECU sensors and connectors
- **DO NOT** remove battery connections when the ignition switch is in 'ON' position (This may damage ECU)
- **AVOID** jump start/push start, Use fully charged battery.
- **DO NOT** run the vehicle if 'CHECK ENGINE' lamp on dashboard is 'ON'.
- If any abnormality in performance of engine occurs - like lack of power- the vehicle to be taken to the **TATA MOTORS** authorised service outlet.

Battery

Battery is placed in Engine compartment.

Check the battery for proper electrolyte level and corrosion on terminals.

WARNING

- * The battery gives off explosive gases during normal operation. A spark or open flame can cause the battery to explode causing very serious injuries.
- * Keep all sparks & open flames and smoking materials away from the battery.
- * Getting electrolyte in your eyes or skin can cause severe burns. Wear protective clothing and a face shield or let a skilled technician do the battery maintenance.
- * Battery contains sulphuric acid (electrolyte) which is poisonous and highly corrosive in nature.

1. Check the battery for electrolyte level with marked lines on the battery outer case.
2. Check Battery terminals for corrosion (a white or yellowish powder). To remove it, cover the terminals with solution of baking soda. It will bubble up and turn brown.

When this stops, wash it off with plain water. Dry off the battery with a cloth or paper towel. Coat the terminal with Petroleum Jelly to prevent future corrosion.

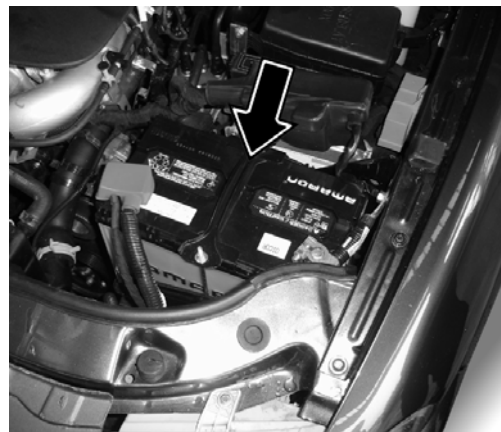

Battery

The use of a wrench to loosen and remove cables from the terminals should be made. Always disconnect the negative (-ve) cable first and reconnect it last. Clean the battery terminals with a terminal cleaning tool or wire brush. Reconnect and tighten the cables, coat the terminals with petroleum jelly. If you need to connect the battery to a charger, disconnect both cables to prevent damage to the vehicle's electrical system.

NOTICE

Charging the battery with the cables connected can seriously damage your vehicle's electronic controls. Detach the battery cables before connecting battery to a charger.

* Swallowing electrolyte can cause fatal poisoning if immediate action is not taken.

Starting the Engine with Jump Leads

Your Safari with a discharged battery may be started by transferring electrical power from a battery in another vehicle. This may be dangerous as any deviation from the following instructions could lead to personal injury or damage resulting from battery explosion, as well as the damage to the electrical systems in both vehicles.

- Never expose the battery to open flames or sparks.
- Do not allow battery electrolyte to come in contact with eyes, skins, fabrics or painted surfaces. The fluid contains sulphuric acid which can cause injuries and damage in the event of direct contact.
- To lessen the risk of injury wear eye protection when working near any battery.
- Make sure that battery providing the jump start has the same voltage as the battery in your vehicle (12 V). Its capacity must not be substantially lower than that of the discharged battery. The voltage and capacity are given on the batteries.
- Do not disconnect the discharged battery from the vehicle.
- Switch off all unnecessary electrical loads.
- Do not lean over the battery during jump starting.
- Do not allow the terminals of one lead to touch those of the other lead.
- Apply hand brake. Place gear shift lever to neutral.

Connect Leads in the Order as shown on next page

- Do not connect lead to negative terminal of discharged battery.
- The connection point should be as far away from the discharged battery as possible.

- Route the leads so that they cannot catch on rotating parts in the engine compartment.
- The engine of the vehicle providing the jump start can be allowed to run during starting.

Attempts to start the engine of the vehicle with the discharged battery should be made at intervals of one minute and should not last longer than 15 seconds. After starting, allow both engines to idle for approximately 3 minutes with the leads still connected.

Wheels & Tyres

Always use only recommended size of wheel rims and tyres. Use of rims and tyres not recommended by us may have adverse effect on vehicle safety and further more could infringe on vehicle regulations.

If you have a flat tyres

- 1) Reduce vehicle speed gradually keeping it is a straight line. Move cautiously off the road to safe place away from traffic. Park the vehicle on a level and firm ground. Apply parking brake & engage 1st gear.
- 2) Turn on Hazard warning switch. Keep advance-warning triangle at least 50 meters behind the vehicle as an indication of breakdown.
- 3) Take out Jack from vehicle which is below the right hand side rear jump seat whose access is by opening the tail gate.

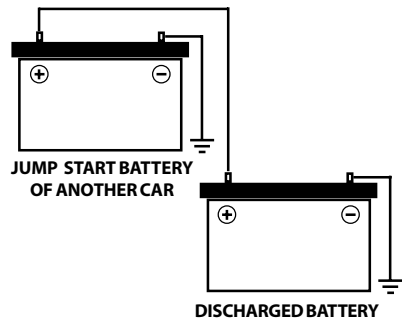

- 4) Take out Spare wheel cover. Pull the cover from top side and then side way to remove from spare wheel.
- 5) Remove the spare wheel-mounting nut by wheel spanner (provided in tool kit). Remove the spare wheel cover mounting bracket and then spare wheel.
- 6) Block the wheel, which is diagonally opposite to the flat tyre. Take out wheel cover and loosen the wheel nut of flat tyre (Do not remove the nut at this stage).
- 7) Set the jack properly at correct jack point as shown in fig. and slowly lift the vehicle with the help of jack handle.
- 8) Remove wheel-mounting nuts and take out flat tyre.
- 9) Roll the spare wheel into position and align the holes in the wheel with studs. Then reinstall the wheel nuts (taper end inward) and tighten them as much as you can by hand.
- 10) Lower the jack completely then tighten the wheel nuts one by one. Put the wheel cover back.
- 11) Restore all the tools and jack at their respective location.
- 12) Place the flat tyre at spare wheel location, put spare wheel cover mounting bracket and tighten the mounting nuts properly. For assembling spare wheel cover, push the cover on the tyre and then press at centre of cover to lock cover on to the bracket. Ensure that the cover is locked on to the spare wheel cover mounting bracket (the sound is heard during assembly).

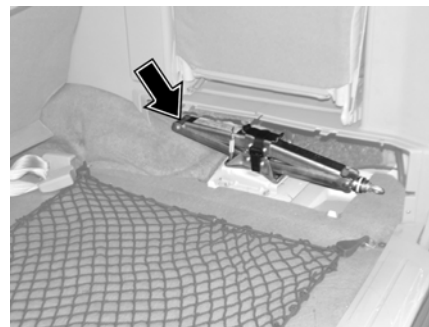

Location of Jack

⚠ CAUTION

- a) Do not lift the vehicle with someone inside.
- b) Raise the vehicle only high enough to remove and change tyre.
- c) Do not work under the vehicle when supported by jack otherwise personnel injury may occur.
- d) Do not start or run the vehicle while supported by jack.

NOTICE

Check tyre pressure and nut tightness of change wheel at nearest Service station. Also, get the puncture tyre repaired.

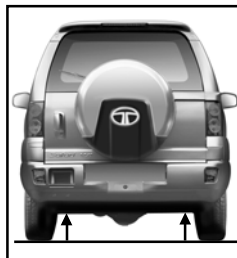

REAR JACKING POINT

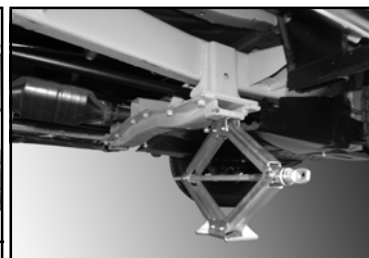
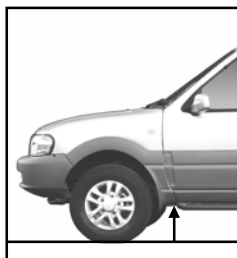

FRONT JACKING POINT

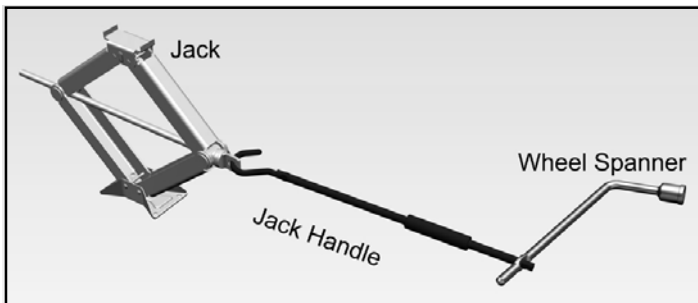

SCISSOR JACK

Wheel Alignment

Correct wheel alignment helps to decrease tyre wear. You should get your vehicle's wheel alignment checked regularly.

In case uneven tyre wear is observed, vehicle's wheel alignment should be checked as soon as possible.

Wheel Balancing

Wheels are balanced at the factory. They may need to be rebalanced at some time before they are worn out. The wheels should be checked for balance if tyre or tube is repaired.

Whenever a tyre or wheel rim is changed tyre needs to be balanced.

1. Permissible imbalance for tyre with rim = 250 gm-cm (max.)
2. Total balance weight should be within 140 gms on each side.
3. Relocate the tyre if the weight required to balance is more than 140 gm.
4. Balance weights are available from 10 gm to 80 gm, 90 gm to 140 gm & 15 gm to 135 gm in steps of 10 gms.
5. Do not use more than one balance weight on one side.

Tyre

Check for the inflation and condition of your TATA SAFARI tyres periodically.

Inflation

Check the pressure in the tyres when they are cold.

Refer to tyre information label fitted on fuel flap inside for correct cold tyre pressure.

You should have your own tyre pressure gauge and use it all times. This makes easier for you to tell if pressure loss is caused by a tyre problem and not by variation between gauges.

Keeping the tyres properly inflated gives you the best combination of riding comfort, handling and tyre life.

Over inflation of tyres makes the vehicle ride bumpy and harsh. Tyres are more prone to uneven wear and damage from road hazards.

Under inflated tyres reduce your comfort in vehicle handling and are prone to failures due to high temperature. They also cause uneven wear.

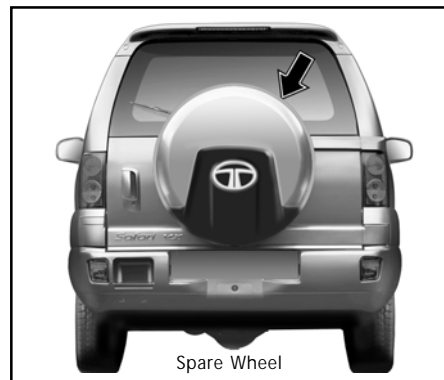
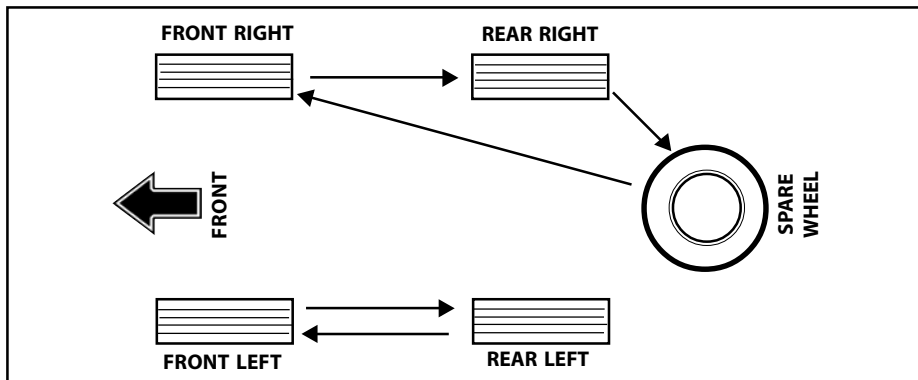

Inspection

Every time you check inflation pressure, you should also examine tyres for damage, foreign objects and wear.

You should look for :

- Bumps or bulges in the tread or the side of the tyre. Replace the tyre if you find either of these conditions.
- Cuts, splits or cracks in the side of the tyre. Replace the tyre if you see the fabric or cord.
- Excessive tread wear.

Tyre Rotation

To help increase tyre life and distribute wear more evenly you

should have tyres rotated at specified intervals or earlier depending on the operation of vehicle.

The illustrations shows how to rotate tyres when normal spare wheel is included in tyre rotation.

Spare Wheel

Spare wheel is located at rear on the tail gate of the vehicle. Recommended tyre pressure with cold tyres.

	Laden	Unladen
Front -	32 PSI (2.2 bar)	30 PSI (2.1 bar)
Rear -	35 PSI (2.4 bar)	35 PSI (2.4 bar)

RADIAL TUBELESS TYRE :

Radial tubeless tyres have following advantages over conventional tube tyres :

- Lesser heat generation as compared to tube tyre
- Absence of tube results in reduction of unsprung weight and improves dynamic stability.
- Tubeless tyres have lower rolling resistance, lesser weight, retain air uniformly and hence improve fuel efficiency.
- Better safety - Less chances of accidents due to sudden air leakage. In case of puncture, the air leakage rate is slower, as air can escape only through the point of puncture, and gives the driver sufficient time to control the vehicle.
- Better heat dissipation - As the compressed air is in direct contact with the metallic rim
- No tube related problems.

Special care for tubeless tyres :

- While removing and refitting the tyre on the wheel rim, take precautions not to damage tyre bead. Use tyre removal and assembly machines. Damage or cut on tyre bead may cause gradual air loss.

- Tubeless tyres are coated with impermeable layer of rubber from inside which holds the air inside the tyre. Do not scratch inside of tubeless tyre with metallic or sharp object. This may cause gradual loss of air.
- If wheel rim gets damaged in the service, get the wheel rim repaired/ replaced immediately. Running the vehicle with damaged rim may cause deflation of tyre and subsequent dislodging of tyre from rim.
- Maintain recommended tyre pressure. Over inflated tyre may cause puncture or bursting of tyre.

NOTE : Life and wear pattern of tyres depends on various parameters like tyre pressure, wheel alignment, wheel balancing, tyre rotation, etc. It also largely depends on vehicle speed, load carried, usage, driving habits, road conditions, etc.

VEHICLE CARE :

Your vehicle is subjected to many external influences such as climate, road conditions, industrial pollution and humidity. These conditions demand regular care of the vehicle body. Dirt, insects, bird droppings, oil, grease, fuel and stone chippings should be removed as soon as possible.

Washing your vehicle :***Following tips while washing your vehicle :*****HAND WASH:**

1. Always wash your vehicle in shade and where the surface is at room temperature.
2. Wash with mild car wash soap like 'Car Shampoo' and use a soft 100% cotton cloth to avoid scratches.
3. To avoid scratches, please wear soft gloves. Remove finger rings, nails, wrist watch while washing.
4. To remove stubborn stains and contaminants like tar, use turpentine or cleaners like 'Stain remover' which are safe for paint surfaces.
5. Avoid substances like petrol, diesel, kerosene, benzene or other solvents that cause damage to paint.
6. Dry your vehicle thoroughly to prevent any damp spots.

7. Rinse all surfaces thoroughly to prevent any traces of soap and other cleaners as this may lead to the formation of stains on the painted surface later.

NOTE

Do not direct high pressure washer fluid/ water jets at electrical devices and their connectors during washing. This is to prevent malfunction / failure of electrical system due to water ingress.

Waxing :

Waxing and polishing is recommended to maintain the gloss and wet-look appearance of your paint finish.

1. Use a good quality polish and wax for your vehicle.
2. Re-wax your vehicle when the water does not slip off the surface and collects over the surface in patches.

Tips for the care of your new vehicle finish :

If your vehicle is washed in an automatic car wash, please remember that the paint can be scratched by type of brushes, unfiltered washing water or the washing process itself. Scratching reduces paint durability and gloss, especially on darker colours. It is suggested to wash the vehicle by hand with cool and clean water using a soft cloth or sponge. Please do not use soap but a car shampoo recommended by your dealer.

Precautions :

1. Always wash your vehicle in shade, avoiding direct exposure to sunlight during washing.
2. Dry wiping your vehicle may lead to the formation of scratches. Always use a soft cloth and clean water while wiping your vehicle.
3. Always keep your vehicle parked in a well ventilated shade. Exposure to heat with entrapped moisture promotes corrosion.
4. Avoid driving on gravel roads, as the possibility of paint chip off due to the impact of stones is high. Also avoid driving on freshly tarred road.
5. External contamination in the form of sap or industrial fall-out may spoil or develop spots on a new finish. Hence avoid parking your vehicle near trees, which are known to drop sap, or near factories.
6. Bird droppings may damage the paint finish, hence bird dropping must be immediately washed off.
7. The paint finish is susceptible to damage in case petrol, brake fluid, liquid from vehicle battery, oil, antifreeze, transmission fluid or windshield solvent spills onto the painted surface. In case of such a spillage immediately rinse the affected area

with water. Avoid wiping the area as far as possible. If wiping is required, wipe the area gently with soft cotton cloth.

8. Avoid using sharp objects to scrap off tar / mud from a painted surface.

Various environmental hazards affecting paints :**The enemy :**

Ultraviolet Rays, Pollution, Tree Sap, Bird Droppings, Car Wash Chemicals, Road Salt, Acid Rain.

Benefits of external enrichment :

- Removal of medium scratches, orange peel, oxidation, dust nibs etc and swirl marks from painted surface.
- Restoration of original gloss levels UV protection after gloss is restored.
- Cleaning and dressing of tyres, Bumpers and all exterior plastic moldings / trims.

Cleaning of carpets :

Vacuum clean the carpet regularly to remove dirt. Dirt will make the carpet wear out faster. Periodically shampoo the carpet to keep it looking new.

Use carpet cleaners (preferably foam type). Follow the instructions that come with the cleaner. Apply it with a sponge or soft brush. Keep the carpeting as dry as possible by not adding water to the foam.

NOTICE

Avoid wiping of painted surface in dry condition as it may leave scratches on the painted surface.

Cleaning of window glasses :

Clean the windows inside and outside with commercially available glass cleaners.

This will remove the haze that builds up on the inside of windows. Use a soft cloth or paper towels to clean all glass and plastic surfaces.

Cleaning of rear windshield glass (With printed circuit):

While cleaning rear windshield glass, avoid to wipe the glass from inside. If required, always wipe it with soft cotton cloth and inline with printed circuit.

NOTICE

Do not rub the glass with a dry cloth across the printed circuit, this may damage the printed circuit.

RFID TAG



RFID TAG is pasted on front windshield from inside. It enables Electronic toll collection.

NOTICE

Do not attempt to rip or tamper the tag. It will disable the functionality of the tag.

Wiper care :

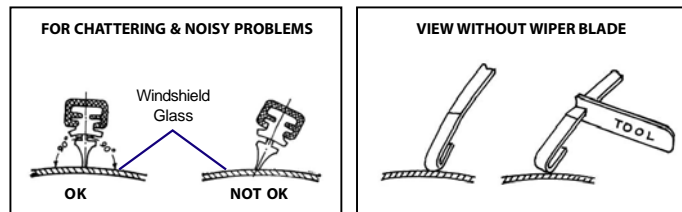

Wiper blade attack angle on windshield glass should be 90° i.e. perpendicular.

Remove wiper blade and root wiper arm on windshield glass in the centre position. Check the gap between arm strip and glass.

Parking vehicle for long duration (on-use maintenance):

- Park the vehicle in covered, dry and well ventilated premises. Engage gear.
- Remove the battery terminal cables (First remove the cable from the negative terminal)
- Make sure the hand brake is engaged.
- Clean and protect the painted parts using protective wax.
- Clean and protect the shiny metal parts using commercially available special compounds.
- Sprinkle talcum powder on the rubber of windscreen wiper and lift them off the glass.
- Cover the vehicle with a cloth or perforated plastic sheet. Do not use sheets of imperforated plastic as they do not allow moisture on the vehicle body to evaporate.
- Do not drain the engine cooling system.

Fuses

All the electrical circuits in your vehicle have fuses to protect them from a short circuit or overload. These fuses are located in 2 fuse boxes. The interior fuse box is below the dash board on driver's side. Remove the fuse box lid by grabbing and pulling down the slot.

The under bonnet fuse box is located in engine compartment on LHS.

Checking and Replacing Fuses

If any electrical unit in your vehicle has stopped functioning, the fuses should be checked first.

1. Turn the ignition key to lock position.
2. Remove the cover of the fuse box.
3. Check each fuse and look for burnt wire inside the fuse. If it is burnt, replace it with one of the spare fuses of same rating or lower.
4. If the replacement fuse of same rating burns out in short time, there is probably a serious electrical problem. Get the vehicle attended at nearest Authorised Workshop.

NOTICE

Ensure that the replaced fuses have the same rating as indicated on the sticker.



Fuse Box - Cabin

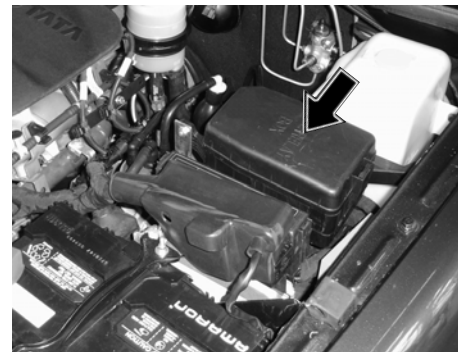

Fuse Box - Engine Compartment

Relays and Transfer Case ECU

Relays are fitted to protect the voltage drawing units from low voltage.

Relays are fitted in 2 locations :

1. In the fuse box situated inside engine compartment.
2. Behind glove box.

ECU for transfer case is fitted under RH seat.

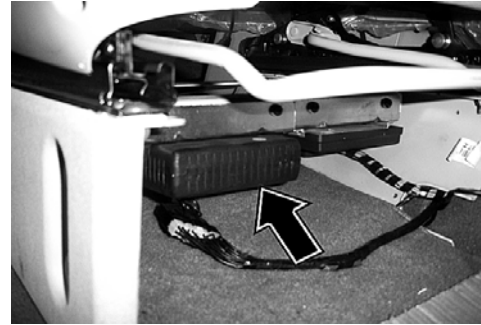

Transfercase ECU under driver's seat

TAKING CARE OF ENVIRONMENT :

Your vehicle is equipped with the EGR (Exhaust Gas Recirculation) System to reduce exhaust pollution.

EGR SYSTEM :

The engine is fitted with EGR valve, EGR pipe, EGR cooler (where-ever applicable), vacuum modulator and associated electrical circuitry. With this, controlled amount of exhaust gas is mixed with intake air of the engine, in part load and speed conditions. This helps in reducing harmful pollutants.

Close Couple Catalytic Converter :

Tata Safari is fitted with Diesel Oxidation Catalytic Converter to reduce exhaust pollution. The two way Catalytic Converter has coating of precious metals which enables conversion of pollutants.

Care of the Catalytic Converter

The Catalytic Converter does not require any special maintenance however, following precautions should be taken for the effective functioning of the converter and to avoid damage to the converter.

- 1 It is mandatory to use Diesel fuel with low sulphur content (Refer recommended fuels). Use of any other diesel fuel can increase the pollutants.
- 2 Avoid parking the vehicle over inflammable materials, such as dry leaves, grass, etc., as the exhaust system is hot enough to initiate "FIRE".

Maintenance of Catalytic Converter

Catalytic Converter should be flushed by giving full throttle (4 to 5 times) in standing condition of vehicle on daily basis. In addition to this it is recommended to run the vehicle at high speeds (80 to 100 kmph) for few km as this will help to flush the carbon soot deposits from exhaust system and catalytic converter. High speed running of the vehicle may be done periodically to avoid chocking of catalytic converter.

Alternatively flushing operation for cleaning the catalytic converter can be done by dry compressed air draft (3 to 4 bar) directed on the honeycomb structure of catalytic converter (after removing from vehicle)

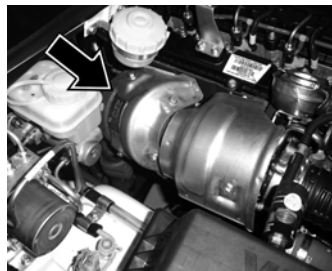

Close Coupled Catalytic Converter

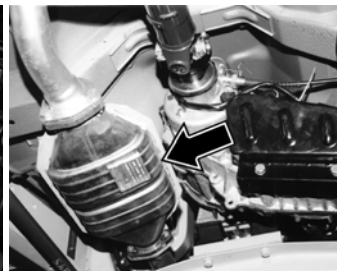

Under Body Catalytic Converter

Variable Turbine Technology- VTT Turbocharger :

Your vehicle is fitted with a turbocharger having variable turbine technology (VTT). Turbocharger is an efficient supercharging device used in our engine. It makes optimal use of thermal energy of engine exhaust gases to run a turbine which in turn drives a compressor to force air under pressure into the inlet manifold. This turbocharger is optimized for higher power output flat torque across large engine speed range and better fuel consumption.

Lubrication of Turbocharger :

The turbocharger rotor assembly is supported by two fully floating bearing bushes in the bearing housing. These bearing bushes are lubricated with finely filtered engine oil from the lubrication system of the engine.

Idle the engine for a while (30 seconds) after starting the engine and before stopping the engine to ensure adequate lubricating oil supply to the turbocharger.

Turbocharger Connections :

All turbocharger connections must be leak-proof. Check air inlet, air outlet, exhaust gas inlet and exhaust outlet connections as well as oil inlet and outlet connections to the turbocharger and tighten the connections where required.

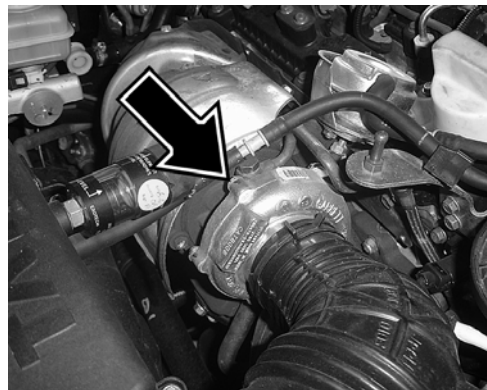

Turbocharger (VTT)

Proper maintenance of air filter, oil filter as well as use of correct grade of oil and adherence to oil change intervals is essential for proper functioning of the turbocharger.

If you suspect any malfunctioning of the turbocharger, take the vehicle to the nearest dealer. Do not remove the turbocharger yourself.

Air Conditioning

The Air Conditioning is a sealed system. Any major maintenance should be done by Authorised Workshop.

There are couple of things which can be done by you to ensure proper working of Air conditioning / Heating.

Periodically check the engine's radiator and air conditioning condensers for leaves, insects and dirt stuck in front surface.

These block the air flow and reduce the cooling efficiency. Use a light water spray from a hose or a soft brush to remove them.

NOTICE

Use only low pressure spray or soft bristle brush to clean condenser and radiator fins.

Run the air conditioning at least once a week during winter season. Run it at least for ten minutes with vehicle at steady speed and engine at normal operating condition. This circulates lubrication oil in the compressor.

For any complaint on A.C. and Heating get it attended at Authorised Workshop.

NOTICE

The system is charged with R 134 (a) - 'Non C.F.C.' refrigerant. Do not top up with any other refrigerant.

Belt Tension :

Check the conditions of belts on the engine. Examine the edge of the belt for cracks or fraying.

Check the tension of the belt by pushing on it with your thumb for Alternator belt and A.C. compressor belt and Power Steering belt as shown in schematic diagram.

The belts should have deflection of 4 to 6 mm.

If the belt tension is not proper, get it attended at the nearest authorised service outlet.

Correct tension of the belt is very critical from belt life and belt noise point of view. It is recommended that belt tension should be measured with clavis gauge to ensure recommended values as given below

Alternator / power steering belt

- Frequency should be 250 + / - 10HZ for new belt measured between alternator & power steering pump span.
- New belt to be retensioned to 220 + / - 10 HZ on vehicle after running for 15 min.

For compressor belt

Span AC to dampers

- Frequency should be 200 +/- 10 HZ
- Belt to be retension to 180 +/- 10HZ on vehicle after running for 15 min.

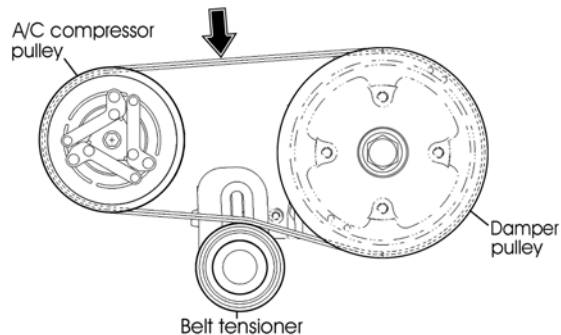

A.C. Compressor Belt Arrangement

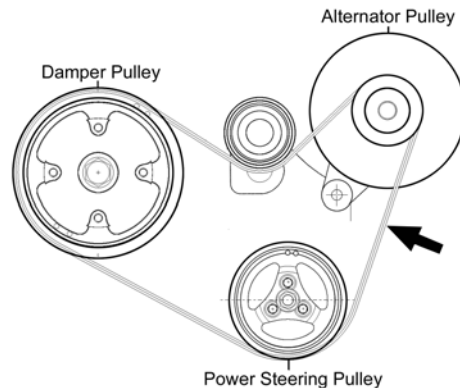

Alternator / Power Steering Belt Arrangement

PRELIMINARY TROUBLE SHOOTING

(These tips are given for your guidance and preliminary jobs to be done in an emergency situation. In normal case, the problems should be attended in an Authorised Workshop by following the repair procedures given in Workshop Manual)

SR. NO.	PROBLEM OBSERVED	CAUSE	ACTION TO BE TAKEN
ENGINE			
1.	Engine not cranking	Dead battery loose or dirty battery connections	<ul style="list-style-type: none">• Get battery checked&/or changed• Clean and tighten battery connections
2.	Engine cranks but does not start	Air in the fuel system	<ul style="list-style-type: none">• Press pear pump for air removal• Check leakages
3.	Engine overheats	Service lamp should glow EMS fuse blown	<ul style="list-style-type: none">• Get defect rectified• Replace the fuse
		Coolant level low	<ul style="list-style-type: none">• Top up coolant, check and correct leakages
4.	Charging indicator continuously remains 'ON'	Hose collapse / torn	<ul style="list-style-type: none">• Get the hose replaced
		Low engine oil level	<ul style="list-style-type: none">• Add oil
		Radiator cap not sealing properly	<ul style="list-style-type: none">• Fit the radiator cap correctly
		A.C. condensers fans not working	<ul style="list-style-type: none">• Get defect rectified
4.	Charging indicator continuously remains 'ON'	Brakes binding	<ul style="list-style-type: none">• Get defect rectified
		Electric fan not working	<ul style="list-style-type: none">• Get defect rectified
4.	Charging indicator continuously remains 'ON'	High delivery pressure in A.C. refrigerant circuit	<ul style="list-style-type: none">• Get defect rectified
		Battery not getting charged due to loose belt drive	<ul style="list-style-type: none">• Get the belt tension adjusted• Replace if broken

SR.NO.	PROBLEM OBSERVED	PROBABLE CAUSE	ACTION TO BE TAKEN
5.	Poor pickup	Loose contact of connectors Blocked fuel filter Clogged air filter EGR malfunctioning	<ul style="list-style-type: none"> • Get defect rectified. • Clean/replace fuel filter element • Clean / replace the element • Get checked & corrected • Check for loose pipes & connections.
6.	Does not accelerate	Accelerator pedal module defective	<ul style="list-style-type: none"> • Get defect rectified
7.	Belt squeal	Loose belt Belt glazed	<ul style="list-style-type: none"> • Get belt tension adjusted • Get belt replaced

CLUTCH

1.	Clutch does not get disengaged	Air in the hydraulic system Less fluid in the master cylinder	<ul style="list-style-type: none"> • Bleed the system • Get the clutch fluid filled
2.	Clutch pedal goes too low	Air in the hydraulic system Less fluid in the master cylinder	<ul style="list-style-type: none"> • Bleed the system • Get the clutch fluid filled
3.	Clutch pedal return sluggish	Blocking of vent in clutch fluid bottle	<ul style="list-style-type: none"> • Open the cap from the bottle & clean the breather hole, if clogged

GEAR BOX

1.	Hard gear shifting / crash engagement	Clutch does not disengage properly	<ul style="list-style-type: none"> • Get the clutch hydraulic system attended
----	---------------------------------------	------------------------------------	--

SR.NO.	PROBLEM OBSERVED	PROBABLE CAUSE	ACTION TO BE TAKEN
REAR AXLE, LIVE FRONT AXLE			
1.	Loss of lubricant (Oil)	Breather hole clogged Differential cover gasket torn Pinion oil seal damaged	<ul style="list-style-type: none"> • Clean the breather hole on the axle housing • Get replaced • Get replaced
2.	Differential housing overheating	Insufficient oil Incorrect lubricant used	<ul style="list-style-type: none"> • Get the oil filled • Drain, flush and get correct lubricant filled
BRAKES			
1.	Poor brakes	Insufficient brake fluid. Air in the system Malfunction of automatic adjuster Vacuum leakage Brake fluid contamination Brake fluid, grease, oil or water on pad /drum Worn brake lining/pad Excessive worn drums at rear soft or weak hose	<ul style="list-style-type: none"> • Get the brake fluid filled • Bleed the system • Check & rectify auto adjuster mechanism or replace • Rectify the leakage • Replace the brake fluid • Replace the leaking line, bleed the system. Clean pad/lining. replace seals if leaking • Get the liners/pad replaced • Replace rear drums • Check & replace
2.	Spongy pedal	Air in the system	<ul style="list-style-type: none"> • Bleed the system

SR. NO.	PROBLEM OBSERVED	PROBABLE CAUSE	ACTION TO BE TAKEN
3.	Brake pulling to one side	Oil on the lining/pad One side shoe (pad) worn Loose brake anchor plate Wheel adjustment disturbed Unequal tyre pressure One side brake pipe clogged	<ul style="list-style-type: none"> • Clean the pad lining • Get the shoe pad replaced • Tighten the bolts • Adjust • Adjust • Get the brake line cleaned & bleed the system
4.	Brake grab	Improperly adjusted parking brake Brake fluid container breather hole clogged No brake pedal free play/brake pedal not returning fully Defective tandem master cylinder	<ul style="list-style-type: none"> • Get correctly adjusted • Clean the hole on the container • Adjust brake pedal • Replace/rectify tandem master cylinder
5.	Brake Squeal	Defective brake lining/pad Glazed lining/pad Loose rivets Wrong lining/pad Shoe return spring broken Front pads /Antisqueal shims rubbing on the disc	<ul style="list-style-type: none"> • Replace • Clean or replace lining/pad • Install rivets properly • Install correct lining/pad • Replace • Get corrected

SR. NO.	PROBLEM OBSERVED	PROBABLE CAUSE	ACTION TO BE TAKEN
ANTI-LOCK BRAKING SYSTEM			
1.	ABS warning lamp stays 'ON'	<p>ABS unit faulty No supply to ABS unit</p> <p>Electrical circuit problem : Intermittent contact, Wiring connections / connections loose/ faulty</p> <p>Component and sensor failure : RPM sensors/toner rings fitting loose, gap disturbances, Sensor signal that deviates from the specified levels</p> <p>Circuit / bulb failure Leakage from hydraulic unit ports Hydraulic unit fluid level low</p> <p>Unusual response and malfunction in the actuators</p>	<ul style="list-style-type: none"> • Check wiring connections & battery condition. • Check wiring harness connections • Check gap between sensor & toner ring • Replace bulb • Eliminate leakage by tightening • Check reservoir fluid level and bleed properly. • Check sensor condition & replace if necessary.

SR.NO.	PROBLEM OBSERVED	PROBABLE CAUSE	ACTION TO BE TAKEN
STEERING SYSTEM			
1.	Hard steering	Less fluid in the power steering tank Air in the system Loose pump belt	<ul style="list-style-type: none"> • Get the fluid topped up to correct level • Get the air removed by bleeding the system • Get the belt correctly adjusted
ELECTRICAL			
1.	No lights on the dash board after turning on the ignition key	Battery terminal got disconnected Battery completely dead	<ul style="list-style-type: none"> • Get the battery properly connected • Get the battery charged • Get the alternator & charging circuit checked
2.	Non functioning electrical accessories such as power windows, head lamps, fuel tank flap, wiper and washer etc.	Blown fuse in the circuit Loose connectors Circuit relay loose in the mounting Defective components	<ul style="list-style-type: none"> • Check for parking lamp fuse • Replace the fuse if blown • Get the connection properly tightened • Tighten the relay correctly • Get the defective component replaced from Authorised Workshop

SR.NO.	PROBLEM OBSERVED	PROBABLE CAUSE	ACTION TO BE TAKEN
AIR CONDITIONING			
1.	Fan motor does not operate	Blown fuse Faulty connection Faulty motor Faulty or poor connection at resistor Faulty fan switch	<ul style="list-style-type: none"> • Replace fuse and correct any wiring short • Properly connect poor connections • Replace motor if no conductance • Replace resistor block if defective • Replace switch
2.	Motor operates but air flow is minimum	Obstruction at evaporator inlet Air leak Faulty thermostat	<ul style="list-style-type: none"> • Clean evaporator • Correctly seal • Adjust or replace thermostat
3.	Insufficient cooling, Air flow normal and compressor operating	Incorrect refrigerant quantity or defect in system aggregates	<ul style="list-style-type: none"> • Get the defect rectified at nearest authorised service centre

SR.NO.	PROBLEM OBSERVED	PROBABLE CAUSE	ACTION TO BE TAKEN
--------	------------------	----------------	--------------------

WIPERS

- | | | | |
|----|---|--|---|
| 1. | Narrow streaks are left on the wind shield making it hard to see | Foreign matter has attached to the blade or edge of the blade is worn out. | Clean the edge of the blade. If streaks still appear, replace the blade |
| 2. | The wiper blade jumps across the windshield and makes a lot of noise (Un-smooth operation) | No proper contact of wiper blade with wind shield glass and wiper blade does not move smoothly across the surface but vibrates, noisily and bounces. | Clean the wind shield. If jumping persists replace the blade. |
| 3. | The wipe leaves large un-wiped spots. | Rubber deformed | Replace the blade |
| 4. | The blade does not contact with the wind shield surface evenly, leaving a large un-wiped surface. | Deformed wiper blade / arm | Replace wiper blade / arm |

SERVICE INSTRUCTIONS:

To achieve economical and trouble free performance, please follow the instructions as stated.

YOUR CAR IS ENTITLED TO FOUR FREE SERVICES (LABOUR ONLY). THE FREE SERVICE COUPONS ARE ATTACHED TO THE SALES INVOICE. PLEASE PRESENT THESE COUPONS TO THE SERVICING DEALER WHILE AVAILING FREE SERVICES.

- 1st free service** - At 1000-1500 km. OR 1 month whichever is earlier
- 2nd free service** - At 5000-5500 km. OR 6 months whichever is earlier
- 3rd free service** - At 15000-15500 km. OR 12 months whichever is earlier
- 4th free service** - At 30000-30500 km. OR 24 months whichever is earlier

All services other than free services are chargeable.

Servicing of your vehicle can be done at any **TATA MOTORS** Authorised Dealer Workshop, **TATA MOTORS** Authorised Service Centre (TASC) or **TATA MOTORS** Authorised Service Point (TASP). The details of their locations are given in this manual.

Warranty claims can be settled by any Tata Motors Authorised Dealer for all failures, while all warranty claims excluding the consideration on the replacement of major aggregates, can be settled by any TASC which is authorised for handling warranty claims. TASPs will not handle warranty repairs.

S E R V I C E S C H E D U L E

SERVICE SCHEDULE

	OPERATION	FREQUENCY X 1000	PDI	1-1.5	5-5.5	15-15.5	30-30.5	45-45.5	60-60.5	75-75.5	90-90.5	105-105.5
7	Change Sedimenter / Water separator	1,05,000 km										x
8	Change Timing Belt & Timing Belt tensioner	1,05,000 km										x
9	Change vacuum hoses for Vacuum Modulator, Turbocharger, EGR valve & throttle valve	60,000 km							x			
	GEAR BOX											
1	*Change oil in gear box (First at 45,000 KM, there after every 90,000 KM)							x				x
2	Change oil in transfer case	45,000 KM						x				x
3	Clean breather in gear box (also Transfer case in case of 4X4)	Every Oil Change					x			x		
	PROPELLER SHAFT											
1	Grease propeller shaft with grease gun (at slip joint - splines end) & Check Centre bracket mounting bolts for looseness. Tighten if necessary	15,000 km				x	x	x	x	x	x	x
	FRONT AXLE (for 4x4) / REAR AXLE											
1	Change oil in axle (First at 15,000 KM, there after every 75,000 KM)					x						x
2	Clean breather in Axle	Every Service	x	x	x	x	x	x	x	x	x	x
	SUSPENSION & STEERING											
1	Grease idler arm (seal type idler arm)	15,000 km				x	x	x	x	x	x	x
2	Check wheel alignment & balancing, chassis height & adjust if necessary	15,000 km				x	x	x	x	x	x	x
3	Check condition of rubber bushes in the following & replace if necessary. 1)Top wishbone 2)Lower wishbone 3)Anti roll bars 4)Rear links 5)Panhard rod 6) Vibration damper	30,000 km			x		x		x			
4	Check shock absorber, bushes & steering damper bushes, replace if necessary	30,000 km			x		x		x			
5	Grease steering spindle and sleeve	30,000 km			x		x		x			
6	Check & adjust front wheel bearing play & Change grease in front hubs	45,000 km			x			x				
7	Change oil in power steering system & change filter element	75,000 km						x				

S E R V I C E S C H E D U L E

SERVICE SCHEDULE

	OPERATION	FREQUENCY X 1000	PDI	1-1.5	5-5.5	15-15.5	30-30.5	45-45.5	60-60.5	75-75.5	90-90.5	105-105.5
	CLUTCH & BRAKES											
1	Check parking brakes, adjust if necessary	15,000 km				x	x	x	x	x	x	x
2	Check front brake pads & rear brake linings. Replace if necessary	15,000 km				x	x	x	x	x	x	x
3	Change Clutch & Brake Fluid (Or 2 years whichever is earlier)	30,000 km					x		x		x	
	ELECTRICALS											
1	Check headlamp focussing & functioning of other electrical equipment	15,000 km			x	x	x	x	x	x	x	x
2	Check specific gravity of battery electrolyte	30,000 km				x		x		x		
	HVAC											
1	Check the HVAC System for Satisfactory Performance & attend if required	Every Service		x	x	x	x	x	x	x	x	x
	WHEELS & TYRES											
1	Tyre rotation	15,000 km			x	x	x	x	x	x	x	x

* Under severe driving conditions, additional maintenance is required. Please Refer to "Additional Maintenance Schedule under severe driving conditions":

Precautions to be taken while cleaning engine compartment : It is recommended to use dry low pressure air. Do not use pressurised water.

ADDITIONAL MAINTENANCE SCHEDULE UNDER SEVERE DRIVING CONDITIONS :

A.	Driving in conditions such as Patrolling, Taxi, Pickup Van, Vehicle Towing, with Trailer Towing											
B.	Driving on Dusty / Sandy roads											
C.	More than 50% (in terms of kms) driving in heavy city traffic											
D.	Frequently operating in mountainous area											
	ITEM	INTERVAL	CONDITION									
			A	B	C	D						
1.	Engine Oil & Oil Filter	Change every 7500 kms.	●	●	●	●						
2.	Air Filter Element	Clean at every 7500 kms. & replace at 30,000 kms.		●								
3.	Front (for 4X4) & Rear Axle Oil Change	Change First at 15000 kms & thereafter at 45,000 kms.	●	●	●	●						

Km. reading	Fuel filled	Fuel consumption	Remarks / complaints

Km. reading	Fuel filled	Fuel consumption	Remarks / complaints

Km. reading	Fuel filled	Fuel consumption	Remarks / complaints

RECORD OF SERVICES PERFORMED

Chassis No.

Recommended Service	Date	Odometer reading km.	Repair Order No.	Servicing Dealer's Signature and Stamp
At km.				
PDI				
1,500				
5,000				
10,000				
20,000				
30,000				
45,000				
60,000				
75,000				
90,000				
1,05,000				

Recommended Service	Date	Odometer reading km.	Repair Order No.	Servicing Dealer's Signature and Stamp
At km.				
1,20,000				
1,35,000				
1,50,000				
1,65,000				
1,80,000				
1,95,000				
2,10,000				
2,25,000				
2,40,000				
2,55,000				
2,70,000				

AC	Air Conditioning	MD	Main Dealer
ACC	Accessories	Min	Minimum
Amp	Ampere	mkg	Meter per Kilogram
Br	Branch	mm	Millimeter
Brg	Bearing	Mtg	Mounting
cc	Cubic Centimeters	No	Number
Cm	Centimeter	PCBU	Passenger Car Business Unit
Dia	Diameter	PDI	Pre-delivery Inspection
EGR	Exhaust Gas Recirculation	PSI	Pounds per Square Inch
FAW	Front Axle Weight	PUC	Pollution Under Control
Fig	Figure	RAW	Rear Axle Weight
FIP	Fuel Injection Pump	RCSM	Regional Customer Support Manager
gm	Gram	RH	Right Hand
GVW	Gross Vehicle Weight	RM	Regional Manager
IGN	Ignition	RPM	Revolution Per Minute
Kg	Kilogram	Sec	Seconds
Kn	Kilometer	Sq.cm.	Square Centimeter
Km/h	Kilometer per hour	TASC	Tata Motors Authorised Service Centre
LH	Left Hand	TASP	Tata Motors Authorised Service Point
Max	Maximum	V	Volts
		W	Watts

A		
Air Bags	22	
Aggregate Numbers-Location	12	
Air Conditioning	52, 134	
Air Filter & Filter Element	105	
Analog Clock	66	
Anti Lock Brake System	79	
Ashtray	61	
Audio Warning	21	
Automatic Hub Lock	82	
B		
Battery	118	
Belt Tension	135	
Bonnet Opening / Closing	70	
Brake Fluid	115	
Brakes	79	
Branded Lubricants	95	
C		
Catalytic Converter	132	
Central Locking System	13	
Child Lock	20	
Cigarette Lighter	60	
Clutch Fluid	115	
Collapsible Steering column	21	
Combi-Switch	33	
Coolants	94	
D		
Door Locks	20	
Driving Controls	28	
Driving in adverse conditions	85	
Driving Safety	89	
E		
ECU	117	
EGR System	132	
Engine Compartment	104	
Engine Coolant	73	
Engine Cooling System	106	
Engine oil	72	
Engine Oil & Oil Filter	108	
Environment Protection	8	
F		
Flat tyre replacement	120	
Follow Me Home Headlamp	64	
Front & Rear Fog Lights	38	
Front / Rear Axle Oil	112	
Front Seat	56	
Front Windshield / Door Glass Demister	54	
Fuel	92	
Fuel Economy	84	
Fuel Gauge	50	
Fuel level	72	
Fuel Tank Flap Switch	38	
Fuel Tank Flap	61	
Fuses	130	
G		
Gauges	47	
Gear Box	78	
Gear Box Oil	110	
Gear Shift Lever	32	
Glove Box	62	
H		
Hazard Warning	39	
Head Lamps & Headlamp Adjustment	113	
Headlamp Leveling Switch	40	
Headrest	57	
Headrest adjustment	18	
High mounted stop lamp	67	
I		
Ignition Switch	29	
Immobiliser- Anti Theft Security System	31	
Important Information	6,7	
Indicators	43	
Instrument Cluster	42	
J		
Jack & Tools	59	
Jump Seats	59	

L

Limited Slip Differential	82
Lubricants	93
Load conscious pressure reducing valve	117

M

Middle Seat	57
Mirror (Inside)	63
Mirror (Motorised)	60
Mirror Demister	39
MP3/DVD player	67
Music System	66

O

Odometer	47
Operating Switch	38

P

Panel Lights	47
Parking Brake	32
Power Steering Fluid	115
Power Windows	55
Preparing to drive	77
Prior to driving – Check List	71

R

Rear Seat	57
Rear Windshield Demister	39
Rear Windshield Wash & Wipe	39
Remote bypass valve	118
Relays	131
Reverse Guiding System	65
Roof Lights	63
Roof Mounted A.C.	54
Roof Rail	88
RPM Meter	49
Running in Period	77

S

Seat Adjustment	58
Seat belt	16
Seat belt precautions	19
Service Schedule	144
Spare Wheel	125
Speedometer	48
Starting / Stopping the engine	76
Steering Lock	29
Steering Wheel Position Adjustment	38
Sunvisors	65

T

Tail lamp	67
Technical Specifications	97
Temperature Gauge	50
Towing the vehicle	88
Transfer case 4X4 operation	82
Transfer case Electric Shift Switch	36
Transfer case oil	111
Trouble Shooting	136
Turbo Charger	133
Tyre	120,123
Tyre Rotation	124

V

Vehicle Care	126
Vehicle Record Sheet	149
Vehicle Specifications	97

W

Warranty-Terms & Condition	10
Wheels & Tyres	120
Wheel Alignment	123
Wheel Balancing	123
Wiper Care	127

Chassis No.

Engine No.

Gear Box No.

At **5,000-5,500 km** OR **6 months** whichever is earlier

please bring your vehicle for this service

as per details given in the **SERVICE SCHEDULE**.

2

**FREE
LABOUR**

TATA MOTORS
WORK DONE TO MY SATISFACTION

Sign. of Customer

Speedo Reading Km. seal O.K. / Broken

R.O. No. Date

Dealer's / Authorised Service Centre's

Stamp & Signature

At the time of delivery of vehicle, please ensure that pre-delivery inspection has been carried out as per details given in the **SERVICE SCHEDULE**.

Chassis No.

Engine No.

Gear Box No.

PDI

**FREE
LABOUR**

TATA MOTORS
WORK DONE TO MY SATISFACTION

Sign. of Customer

Speedo Reading Km. seal O.K. / Broken

R.O. No. Date

Dealer's / Authorised Service Centre's

Stamp & Signature

Chassis No.

3

**FREE
LABOUR**

Engine No.

At **15,000-15,500 km** OR **12 months** whichever is earlier

please bring your vehicle for this service

as per details given in the **SERVICE SCHEDULE**.

TATA MOTORS
WORK DONE TO MY SATISFACTION

Sign. of Customer

Speedo Reading Km. seal O.K. / Broken

R.O. No. Date

Dealer's / Authorised Service Centre's

Stamp & Signature

Chassis No.

Engine No.

At **1,000-1,500 km** OR **1 month** whichever is earlier

please bring your vehicle for this service

as per details given in the **SERVICE SCHEDULE**.

TATA MOTORS
WORK DONE TO MY SATISFACTION

Sign. of Customer

Speedo Reading Km. seal O.K. / Broken

R.O. No. Date

Dealer's / Authorised Service Centre's

Stamp & Signature

1

**FREE
LABOUR**

Chassis No.

4

Engine No.

At **30,000-30,500 km OR 24 months** whichever is earlier

please bring your vehicle for this service

as per details given in the **SERVICE SCHEDULE.**

**FREE
LABOUR**

TATA MOTORS
WORK DONE TO MY SATISFACTION

Sign. of Customer

Speedo Reading Km. seal O.K. / Broken

R.O. No. Date

Dealer's / Authorised Service Centre's

Stamp & Signature

Chassis No.

5

Engine No.

At **45,000-45,500 km OR 36 months** whichever is earlier

please bring your vehicle for this service

as per details given in the **SERVICE SCHEDULE.**

**FREE
LABOUR**

TATA MOTORS
WORK DONE TO MY SATISFACTION

Sign. of Customer

Speedo Reading Km. seal O.K. / Broken

R.O. No. Date

Dealer's / Authorised Service Centre's

Stamp & Signature



TATA MOTORS | SERVICE

RESPONSIVE • RELIABLE • BEST VALUE



TATA MOTORS | SERVICE
RESPONSIVE



24x7

ON-ROAD ASSISTANCE
1800 209 7979



TATA MOTORS | SERVICE
RESPONSIVE



DOORSTEP SERVICE

MOBILE SERVICE



TATA MOTORS | SERVICE
RESPONSIVE



ONLINE SERVICE

APPOINTMENT
AT A CLICK



TATA MOTORS | SERVICE
RESPONSIVE



QUICK REPAIR

REPAIR IN MINUTES



TATA MOTORS | SERVICE
RESPONSIVE



SPEED-O-SERVICE

FASTER SERVICE
DELIVERY



TATA MOTORS | SERVICE
BEST VALUE



EXTENDED WARRANTY

UP TO 4 YEARS



TATA MOTORS | SERVICE
BEST VALUE



RAPID REPAIR

MINOR BODY REPAIRS



TATA MOTORS | SERVICE
BEST VALUE

TOP

ORIGINAL PARTS
UNMATCHED QUALITY



TATA MOTORS | SERVICE
BEST VALUE



VALUE CARE

MAINTENANCE PLANS



TATA MOTORS | SERVICE
RELIABLE



DIAGNOSTIC EXPERT

HIGH SKILLED TECHNICIAN



TATA MOTORS | SERVICE
RELIABLE



QUALITY SERVICE

SERVICE QUALITY
ASSURANCE

HORIZONEXT



CALL US : 1-800-209-7979
MAIL US : customersupport@tatamotors.com
VISIT US : www.customercare@tatamotors.com

2887 5840 99 01

TATA MOTORS LIMITED

Designed & Developed by : Content Creation & Publication, PVBU, Tata Motors, Pune