



ARIA

OWNER'S MANUAL & SERVICE BOOK

TATA MOTORS
HORIZONEXT

CAR IDENTIFICATION AND RECORD

OWNER'S NAME _____

ADDRESS _____

SELLING DEALER CODE _____

DATE OF DELIVERY _____

DATE OF REGISTRATION _____

REGISTRATION NO. _____

CHASSIS NO. _____

ENGINE NO. _____

GEAR BOX NO. _____

REAR AXLE NO. _____

BATTERY MAKE _____

BATTERY SR. NO. _____

BATTERY CODE _____

THE WARRANTY ON THIS CAR IS VALID ONLY IF THE DETAILS ARE FILLED, SIGNED & STAMPED BY THE SELLING DEALER.

**DEALER'S SIGNATURE
AND STAMP**



**Following items are provided with
your TATA ARIA :**

1. Owner's Manual & Service Book
2. First Aid Kit
3. Advance Warning Triangle
4. Jack & Handle
5. Spare Headlamp Bulbs - 2 Nos.
6. Spare Fuses (Provided in fuse box)
7. Tool Kit
8. Infotainment System Manual
(If fitted)



TATA ARIA

OWNER'S MANUAL & SERVICE BOOK

This owner's manual is advised to be kept in the vehicle at all the times.

TATA MOTORS
Passenger Vehicle Business Unit
• Mumbai • Pune •

- Should any question or query exist regarding any aspect of your vehicle, please contact the nearest **TATA MOTORS** dealer, who will be pleased to assist you.
- The recommended routine maintenance servicing along with any running repairs that may be required, should be entrusted to **TATA MOTORS** dealership or to **TATA Authorised Service centres (TASCS)** or **TATA Authorised Service Points (TASPS)** to ensure that only latest methods and genuine **TATA MOTORS** replacement parts are used for the continued reliability, safety and performance of the vehicle.
- Some of the items / accessories / features shown / given in this book may not be fitted on your vehicle, but they are applicable for other variants of **TATA ARIA**.
- Copyright 2014 **TATA MOTORS**
- All rights reserved. The material in this manual may not be reproduced or copied, in whole or in part, in any form without written permission from **TATA MOTORS**.
- In the event of the Vehicle being sold, please ensure that this manual is left in the vehicle for the reference of the new owner.

This owner's manual & service book includes information on the operation and maintenance of various equipment installed on the different variants of **TATA ARIA**. Please note that this manual applies to all the models and explains all equipment including options not installed on your vehicle.

**Dear Customer,**

Thank you for choosing **TATA ARIA**.

TATA ARIA is a crossover type of vehicle that has been built on a completely new platform.

ARIA comes with **TOD (Torque-On-Demand)** transference. It automatically and smoothly delivers four-wheel drive operation as and when the driving conditions demand.

For enhanced safety of occupants, the ARIA has **SRS** (Air bag), **ABS** (Anti lock Braking System), and **ESP** (Electronic Stability Program) in addition to having disc brakes on all its four wheels. Advanced electronics are employed in the ARIA to control its various functions. **Infotainment System** provided in the ARIA is a source of both, information as well as entertainment to the passengers. **Reverse Parking Assist System** helps in directing the car safely. The interiors of the Aria are luxury personified with the soft touch dashboard having matching trim colour.

Powering the ARIA is **TATA MOTORS** proven **2.2 Litre VARICOR Engine** that aids drivability, especially while tackling rough hard-hitting roads.

This book gives you all the information necessary for making your drive a wonderful experience.

We wish you a safe and wonderful driving experience.

TATA MOTORS

**INTRODUCTION****VALUE ADDED SERVICE**

1	24X7 On Road Assistance	2
2	Extended Warranty	6
3	Anti-rust, Sound Deadening & Engine Waxing	8
4	Exterior & Interior Enrichment Program	10

ENVIRONMENT PROTECTION 13**WARRANTY-TERMS & CONDITIONS 15****GETTING STARTED 17**

1	E-Key and Remote Keyless Entry	17
2	Door Locking / Unlocking	18
3	Child Lock & Tail gate Opening / Closing	19
4	Steering Lock cum Ignition Switch	20
5	Seat & Seat Adjustments	21
6	Seat Belt	27
7	Rear View Mirrors - Inner & Outer	31
8	Steering Height Adjustment	32
9	4X2 & 4X4 Auto Mode Selection Switch	32
9	Head Light Controls	33
10	Power Windows	35
11	Dashboard	36

DRIVING CONTROLS

1	Gear Shift Lever	37
2	Parking Brake	37
3	Combi-Switch	38
4	Instrument Cluster- Gauges & Indicators	42
5	Facia Switches	57
6	Steering Wheel Switches	58
7	HVAC - Manual & FATC	59
8	TFT Display	66

INTERIORS

1	Sun visors & Vanity Mirror	67
2	Grab Handle / Coat Hook	68
3	Goggle Case & Overhead Storage Bin	68
4	Cup Holders	69
5	Utility Pockets on Door Trims	69
6	Power Socket	70
7	Glove Box & Top Stowage Box	71
8	Interior Lamps	72
9	Music System-Speakers/Antenna/USB port	73

EXTERIORS

1	Head lamp	75
2	Fog Lamp	75

3	Tail Lamp	75
4	Registration Plate Lamp	76
5	High Mounted Stop Lamp	76
6	Puddle Lamp / Door Lamp	76
7	Cargo Lamp	76
8	Reflex Reflectors	77
9	Fuel Flap Opening / Closing/Emergency	77
10	Bonnet Opening / Closing	78

SPECIAL FEATURES

1	Immobilizer	79
2	Air Bags (SRS)	81
3	ABS (Anti-lock Braking System)	86
4	ESP (Electronic Stability Program)	88
5	Cruise Control	89
6	TOD (Torque On Demand)	91
7	Rain and Light Sensor	92
7	Reverse Parking System	94

DRIVING

1	Safety Checks Before Driving	98
2	Driving Safety	99
3	Fuel Economy	100
4	Starting / Stopping & Parking	101
5	Running-In	102

6	Brakes & Braking	103
7	Driving In Adverse Condition	104
IN CASE OF EMERGENCY		
1	Advanced Warning Triangle / Jack / Tools	107
2	If You Have Flat Tyre	108
3	Jacking Points / Jack Location	109
4	Towing The Vehicle	111
5	Starting the engine with jump leads	112
6	Fuses & Relays	113
7	Bulb Specification	118
9	Head lamp bulb replacement	119
8	Tail lamp bulb replacement	121
9	Preliminary Trouble Shooting	122
MAINTENANCE & CAR CARE		
1	Engine Compartment	131
2	Air Filter	132
3	Engine Oil Level Check	132
4	Engine Coolant Level Check	132
5	Brake Fluid Level Check	133
6	Power Steering Fluid Level Check	133
7	Windshield Washer Fluid Level Check	133
8	Turbocharger	134

9	Intercooler	134
10	Catalytic Converter	135
11	Tyres	136
12	Battery	139
13	Window Glasses	140
14	Wiper	140
15	Vehicle Care	141
TECHNICAL INFORMATION		
1	Fuel/Coolant & Lubricants	143
2	Technical Specification	146
3	Vehicle Dimensions	150
4	Chassis & Aggregate Numbering Locations	151
VEHICLE SERVICE		
1	PDI Service	152
2	Service Schedule	154
3	Service Coupons	

SAFETY AND VEHICLE DAMAGE WARNINGS

In this manual, you will see **CAUTION** and **NOTICE WARNINGS**.

CAUTION

This is a warning. May cause injury to people if the warning is ignored. You are informed what you must or must not do in order to avoid or reduce the risk to yourself and other people.

NOTICE

This is a warning. May cause damage to the vehicle or its equipment if the warning is ignored. You are informed what you must or must not do in order to avoid or reduce the risk of damage to your vehicle and its equipment.

WARNING

Indicates a strong possibility of severe personal injury or death if the instructions are not followed.

SAFETY SYMBOL

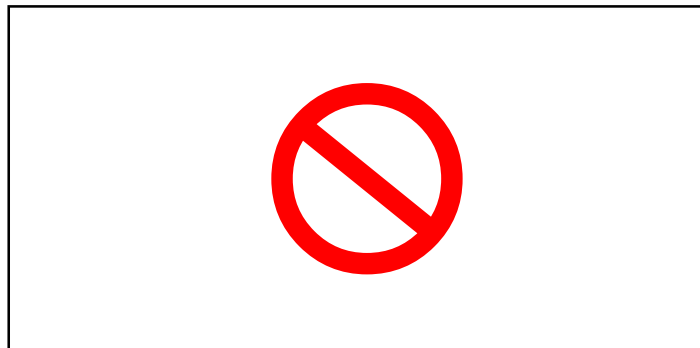

In this manual, you will also see a circle with a slash. This means "Do not", "Do not do this", or "Do not let this happen".

Dear Customer,

It is our never ending responsibility and endeavor to ensure that our customer's expectations are fulfilled comprehensively. To fulfill your vehicle service needs, we recommend the following :

- 1) Extended Warranty*
- 2) Anti Rust / Sound Deadenning / Engine waxing treatment*
- 3) Vehicle detailing programming : Exterior Enrichment and Interior Enrichment Program*

These products shall help maintain optimum vehicle performance and shall enhance vehicle life.

We have tied up with best in the Class companies, who would bring you the above world class products at affordable prices. The above products are available with all our Dealers, TASCs and TASPs.

Our Dealer Service marketing executive shall explain to you the benefits of the above mentioned products.





Dear Customer,

It is our responsibility and our endeavour to ensure that you have our complete service backup if ever, wherever and whenever you need the same. When you have a road network that spans wide area, the probability of a breakdown happening within hailing distance of a **TATA MOTORS** Authorized Workshop is very low. It is Precisely for this reason, we have tied up with MyTVS, who will provide breakdown assistance including towing to the nearest **TATA MOTORS** Authorized Workshop through their Authorized Service Providers (ASP)

The **24X7 On Road Assistance** Program shall be automatically available to your vehicle for the duration of Warranty period. The program shall also be available, if you avail the same post warranty.

Response Time ** for the On Road Assistance Program

Within City Limits	60 minutes
On State or National Highways	90 minutes
Ghat Roads and other places	120 minutes +/-

** (The response time will depend on the location, terrain, traffic density and the time of the day.)

Standard procedure when calling for On Road Assistance in case of a breakdown:

- Dial the toll free help line number – **1 800 209 7979**
- Identify your vehicle with the Vehicle chassis number that is available in the Owners Service manual.
- Explain your exact location with landmarks and tell us about the problem you face with the vehicle.
- Park your vehicle on the edge of the road, open the bonnet and put on the hazard warning signal.
- Place the advance warning triangle supplied with the vehicle approx. 3 m from the vehicle in the direction of on coming traffic.

COVERAGE UNDER THE 24 X 7 ON ROAD ASSISTANCE PROGRAM

I. The **24x7 On Road Assistance** Program Service covers the following services on your vehicle during warranty period.

- Wheel change through spare wheel.
- Arrangement of fuel. (Fuel cost will be chargeable at actual cost)
- Re-opening the vehicle in cases of key lock out.
- Rectification of electrical problems related to battery, fuses etc.
- On spot repairs for complaints repairable at site.^
- Vehicle to vehicle towing or winching & towing for non accident cases up to the nearest **TATA MOTORS** authorized workshop. Towing charges at actual cost beyond the same to be paid to the ASP in cash. (Any ferry or toll charges levied in relation to the vehicle being towed to be paid by the customers in actuals in cash).

For accident cases, towing charges to be borne by the customer.

II. The **24x7 On Road Assistance** Program coverage on availing the 24X7 policy, post warranty, i.e. upto maximum of 6 instance of assistance in one year for both the plans-Basic and Premium. In the premium plan, this includes 1 instance of towing upto the nearest **TATA MOTORS** authorised workshop.

EXCLUSIONS

24x7 On Road Assistance Program does not apply to

- Cost of parts consumables and labour for such repairs not covered under warranty*. These charges are to be settled with ASP in cash.
- Toll or ferry charges paid by ASP in reaching to the breakdown site to be settled with ASP in actuals in cash.
- Cases involving accident, fire, theft, vandalism, riots, lightning, earthquake, windstorm, hail, tsunami, unusual weather conditions, other acts of God, flood, etc.
- Vehicles that are unattended, un-registered, impounded or abandoned.
- Breakdown/defects caused by misuse, abuse, negligence, alterations or modifications made to the vehicle.
- Lack of maintenance as per the maintenance schedule as detailed in the owner's manual.

- Cases involving racing, rallies, vehicle testing or practice for such events..

DISCLAIMER :

- The service is not available in the some part of J&K and in Union Territories of Andaman & Nicobar Islands and Lakshwadeep.
- **The reach time is indicative & the actual reach time will be conveyed by the call centre at the time of breakdown call.
- The reach time can vary depending on the traffic density & time of the day.
- The reach time indicated does not account for delays due to but not limited to acts of God, laws, rules & regulations for time being in force, orders of statutory or Govt. authorities, industrial disputes, inclement weather, heavy down pour, floods, storms, natural calamities, road blocks due to accidents, general strife and law & order conditions viz. fire, arson, riots, strikes, terrorist attacks, war etc.
- ^ On spot repairs at breakdown site shall depend on nature of complaints & will be as per the discretion of the ASP.
- *The decision for free of charge repairs will be as per the warranty policy & procedures of **TATA MOTORS LTD.**

and as per the interpretation of the same by ASP. You will be duly informed by the ASP & call centre for the change applicable if any.

- All charges wherever applicable need to be settled directly with the ASP.

EXCLUSION OF LIABILITIES :

- It is understood that **TATA MOTORS** shall be under no liability whatsoever in respect of any loss or damage arising directly or indirectly out of any delay in or non delivery of, defect/deficiency in service/parts provided by ASP.
 - In case vehicle cannot be repaired on-site, customers are advised to use the towing facility for taking their vehicle to the nearest **TATA MOTORS** authorized workshop only. In no condition will the vehicle be towed to any unauthorized workshop. **TATA MOTORS** will not be responsible for any repairs carried out in such unauthorized workshop.
 - Customer are advised to take acknowledgment from the ASP for the list of accessories/extra fittings and other belongings in the vehicle as well as the current condition related to dents/scratches breakages of parts/fitments of the vehicle at the time of ASP taking possession of the vehicle & to verify these items when delivery is taken back by them, Claim for loss of or damage to items, if any should be taken up with ASP directly. **TATA MOTORS** shall not be responsible for any such claims, damages/ loss or any deficiency of service of the ASP.
- Vehicles will be handled, repaired & towed as per the customer's risk & **TATA MOTORS** shall not be liable for any damages / claims as a result of the same.
 - Services entitled to the customers can be refused or cancelled on account of abusive behaviour, fraudulent representation, malicious intent and refusal to pay the charges for any charges related services and spare parts during service or on previous occasion on part of the customer.
 - On site repairs may be temporary in nature. The completion of repairs does not certify the road worthiness of the vehicle. The customer is advised to ensure temporary repairs carried out onsite is followed by permanent repairs at **TATA MOTORS** Authorized Workshop at the earliest.
 - Terms and conditions and service coverage, exclusions etc. are subject to change without notice.

TATA MOTORS recommends the purchase of Extended its warranty program.

Coverage : Mechanical + Electrical

Benifits :

- Insures you against unforeseen break down repair bills.
- Documentation is simple and hassle free.
- Near cashless & speedy claim settlement.

Term :

- **36 + 12 or 150000 kms** whichever occurs first

Extended Warranty available in the dealership from where you have purchased your vehicle. We strongly recommend purchase of Extended Warranty at time of purchase of your vehicle. Surcharge applicable on purchase of Extended Warranty after 90 days of purchase of vehicle. **Extended Warranty can be availed till 421 days from date of purchase of vehicle.** The Dealer Service Marketing Executive shall explain to you the Terms and conditions, Coverage and Owner's responsibility.

Extended Warranty Booklet & Cover Note :

The Extended Warranty booklet and cover note is the basis of the contract between **TATA MOTORS LIMITED** and the Owner of the vehicle shown on the Extended Warranty booklet. The Customer to retain this booklet and the same to be produced to the dealer while claiming benefits under Extended Warranty.



Note :

- The 12 month extended warranty does not follow the 36 month Manufacturer's warranty.
- The extended warranty comes into force once the manufacturer's warranty expires e.g. after 36 Months.
- It is more restrictive as by the time it comes into force the vehicle is already 36 months old.

What is covered ?

- Mechanical / Electrical break down as defined in this warranty and confirmed by the dealer within the stipulated terms and conditions.
- Tata Motors dealer shall either repair or replace any part found to be defective with a new part or an equivalent at no cost to the owner for parts or labour.
- Such defective parts which have been replaced will become property of **TATA MOTORS LIMITED**.
- Comprehensive list of parts covered is mentioned in the page 9-12 of the Extended Warranty Booklet.

What is not covered ?

Please refer the Extended Warranty Booklet for details of the exclusion list.

Owner's Responsibility :

- Proper use, maintenance and care of the vehicle in accordance with the instructions contained in the Owner's Manual and Service Booklet. The records of the same to be ensured in Owner's Manual.
- Retention of maintenance service bills.

I / We have been explained the Terms and conditions, Coverage and Owner's responsibility by the Dealer Service Marketing Executive.

I wish to avail / Do not wish to avail extended warranty policy.

Customer's Sign

Dealer's Sign

Why are Corrosion Protection Waxes necessary?

Corrosion is caused by:

Water / salt water acid rain & atmospheric fallouts.

Critical areas are:

Cavities: joints, crevices, spot welds, underbody

- Corrosion is the most important factor when we talk about the vehicle life. If you treat your car you can prolong the life.
- It is very dangerous to drive around in a corroded car.
- The corrosion creeps onto the car from the inside and from the outside. The most dangerous kind of corrosion is often not discovered until it is too late.

Benefits of Anti -Rust treatment :

- A professionally applied range of world class products offering real value to the new and used car customer.
- The treatment has been developed to withstand the harshest environmental and climatic conditions (rust. Pollutants, stone and gravel impact, etc)
- Insulate cabin space from external noises.
- Expensive tin work and Denting / Painting avoided.
- Higher resale value for the car.
- Higher safety – uncorroded vehicle
- Upto 60 months warranty & 10 free checkups available



Engine Wax Treatment :

Engine Wax is a beige coloured transparent lacquer coating on the engine compartment.

- Corrosion Prevention for the Engine compartment
- Neat, clean and New Look to Engine compartment
- No effect on MPFI vehicles
- Engine wax can withstand upto 200 degrees temp
- No need of cleaning the engine compartment with diesel once engine wax is sprayed
- Life of over a year

Sound Deadening System :

Door vibration deadeners - These pads when stuck on the insides of the sheet metal increase sheet metal rigidity, reduce vibrations and increase riding comfort.

- Used for reducing the sheet metal vibration in a vehicle.
- Product to be used once in the life of the vehicle - Life Time Warranty
- Effect is Life long i.e. until & unless pads are physically removed.
- Negligible increase in Weight & hence no effect on fuel consumption.
- Areas covered - four doors, rear quarter panels & dicky. In case of diesel vehicles, can be used in the bonnet.

TATA MOTORS has tied up with **M/s Wuerth** , **M/s Autokrom**, **M/s 3M India Ltd** & **M/s Bardahl** for these world class treatment at affordable prices. These treatments are available in all authorized workshops. The Dealer Service Marketing Executive will explain to you the benefits and terms and conditions of this treatment.

I / We have been explained the Benefits, Terms and conditions and the prices of these treatments by the Dealer Service Marketing Executive

I wish to avail / Do not wish to avail these treatment

Customer Signature

Dealer Signature

Vehicle Exterior Enrichment :

Why vehicles are painted?

- For Corrosion protection of the metal surfaces.
- Ease of application from other corrosion protection treatments.
- Cheaper than other corrosion protection methods eg.galvanizing, anodizing.
- For decoration and identification.

Various Environmental Hazards affecting paints :

- Environmental hazards: destroy your vehicle's finish.
- Even as your new vehicle rolls off the assembly line, the paint is not protected.

The enemy :

Ultraviolet Rays, Pollution, Tree Sap, Bird Droppings, Car Wash Chemicals, Road Salt, Acid Rain.

Benefits: Vehicle Exterior Enrichment

- Removal of medium scratches, orange peel, oxidation , dust nibs etc & swirl marks from painted surface.
- Restoration of original gloss levels UV protection after gloss is restored.
- Cleaning & dressing of tyres, Bumpers & all exterior plastic moldings/trims.

Tata Motors has tied up with **M/s Autokrom**, **M/s 3M** & **M/s Wuerth** for this world class treatment at affordable prices. This treatment is available in all authorized workshops. The Dealer Service Marketing Executive will explain to you the benefits and terms and conditions of this treatment.



Vehicle Interior Enrichment***Why protect your new car's fabric interior ?***

- Someone will soil your vehicle's fabric carpet or seats.
- A significant detractor from your vehicle's resale value.
- A permanent stain on your vehicle's interior fabric.

The enemy :

Drink Spills - Food Stains - Mud - Ultraviolet Rays Pets - Traffic

Benefits: Vehicle Interior Enrichment

- Removal of medium stains and dirt from all interior parts of the car i.e carpet, upholstery and roof lining.
- Cleaning of windshield and all windows (inside and outside)
- Dressing of all internal plastics (eg: door pad trims)and rubber parts.
- The treatment involves cleaning and dressing of All parts of the exposed interiors.
- Specialised protection for seat fabric from liquid spills.

Tata Motors has tied up with **M/s Wuerth , M/s Autokrom & M/s 3M India Ltd** for this world class treatment at affordable prices. This treatment is available in all authorized workshops. The Dealer Service Marketing Executive will explain to you the benefits and terms and conditions of this treatment.

I / We have been explained the Terms and conditions, Coverage and Owner's responsibility by the Dealer Service Marketing Executive.

I wish to avail / Do not wish to avail extended warranty

Customer's Sign

Dealer's Sign

VALUE ADDED SERVICES

TATA MOTORS is committed to produce the vehicles using environmentally sustainable technology. A number of features have been incorporated in Tata Motors passenger vehicles which have been designed to ensure environmental compatibility throughout the life cycle of the vehicle. We would like to inform you that your vehicle meets BS-IV emission norms and this is being regularly validated at the manufacturing stages.

As a user you too can protect the environment by operating your vehicle in a proactive manner. A lot depends on your driving style and the way you maintain your car. We have given a few tips below for your guidance.

DRIVING

- Avoid frequent and violent accelerations.
- Do not carry any unnecessary weight on the vehicle as it over loads the engine.

- Avoid using devices requiring high power consumption during slow city traffic condition.
- Monitor the vehicle's fuel consumption regularly and if showing rising trend get the vehicle immediately attended at the Company's Authorised Service Outlets.
- Switch off the engine during long stops at traffic jams or signals. If you need to keep the engine running, avoid unnecessary revving it up or stopping and starting.
- It is not necessary to rev up the engine before turning it off as it unnecessarily burns the fuel.
- Shift to higher gears as soon as it is possible. Use each gear upto 2/3rd of it's maximum engine speed. A chart indicating gear shifting speeds is given in this book.

MAINTENANCE

- Ensure that recommended maintenance is carried out on the vehicle regularly at the Authorised Service Outlets.
- As soon as you see any leakages of oil or fuel in the vehicle we recommend to get it attended immediately.
- Use only recommended grades and quantity of lubricants and clean/uncontaminated and correct fuels.
- Get your vehicle checked for emission periodically by authorised dealer.
- Ensure that fuel filter, oil filter and breather are checked periodically and replaced, if required, as recommended by Tata Motors.
- Do not pour the used oils or coolants into the sewage drains, garden soil or open streams. Dispose the used filters and batteries in compliance with the current legislation.

ENVIRONMENTAL PROTECTION

- Do not allow unauthorised person to tamper with engine settings or to carry modifications on the vehicle.
- Never allow the vehicle to run out of fuel.
- Parts like brake liners, clutch disc should be vacuum cleaned. Do not use the compressed air for cleaning these parts which may spread the dust in the atmosphere.

While carrying out the servicing or repairs of your vehicle you should pay keen attention to some of the important engine aggregates and wiring harness which greatly affect emission. These components are :

1. Fuel injection equipments : pump, rail, Injectors, Nozzles and high pressure pipes.
2. Air Intake & Exhaust system especially for leakages.
3. Cylinder head for valve leakage.

4. All filters such as air, oil & fuel filters (check periodically).
5. Turbocharger.
6. EGR System & components.
7. Electrical connections
8. 'Service' lamp continuously glows, please take the vehicle to Service Station.
9. Catalytic Convertor
10. EMS wiring harness i.e. electrical connections to all sensors and actuators.

This Owner's manual contains further information on driving precautions and maintenance care leading to environment protection. Please familiarise yourself with these aspects before driving.

We **WARRANT** each **TATA ARIA** vehicle & parts thereof manufactured by us to be free from defect in material and workmanship, subject to the following terms & conditions :

1. This warranty for **engine (Varicor)** fitted in the vehicle shall be for a **period of 36 months OR 1,50,000 kms**, whichever is earlier from the date of sale of the vehicle.

The warranty for the **rest of the vehicle** shall be for a **period of 36 months OR 1,00,000 kms**, whichever is earlier from the date of sale of the vehicle.

2. Our obligation under this warranty shall be limited to repairing or replacing, free of charge, such parts of the vehicle which, in our opinion, are defective, on the vehicle being brought to us or to our dealers within the warranty period. The parts so repaired or replaced shall also be warranted for quality and workmanship but such warranty shall be co-terminus with this original warranty.

3. Any part which is found to be defective and is replaced by us under the warranty shall be our property.
4. As for such parts as tyres, batteries, infotainment system, electrical equipment and fuel injection equipment, not manufactured by us but supplied by other parties, this warranty shall not apply. However buyers of the vehicle shall be entitled to, so far as permissible by law, all such rights as we may have against such parties under their warranties in respect of such parts. Our Dealers/ TASC's will assist the purchaser in taking up the complaint with the respective manufacturers and their decision on the warranty will be final.
5. This warranty shall not apply if the vehicle or any part thereof is repaired or altered otherwise than in accordance with our standard repair procedure, or by any person other than our sales or service establishments, our authorised dealers or service centres or service points in any way so as, in our

judgement which shall be final and binding, to effect its reliability, nor shall it apply if, in our opinion which shall be final and binding the vehicle is subjected to misuse, negligence, improper or inadequate maintenance or accident or loading in excess of such carrying capacity as certified by us, or such services as prescribed in our Owner's Manual and Service Book are not carried out by the buyer through our sales or service establishments, our authorised dealers or service centres or service points.

6. This warranty shall not cover normal wear and tear or any inherent normal deterioration of the vehicle or any of its parts arising from the actual use of the vehicle or any damage due to negligent or improper operation or storage of the vehicle. This warranty shall not apply to normal maintenance services viz. oils & fluid changes, head lamps focussing, fastener retightening, wheel balancing, tyre rotation, adjustment

WARRANTY - TERMS & CONDITIONS

- of valve clearance, fuel timing, ignition timing and consumables like bulbs, fuel filters and oil filters etc. This warranty shall not apply to any damage or deterioration caused by environmental pollution or bird droppings. This warranty shall not apply to V-belts, rubber parts, hoses and gas leaks in case of air conditioned vehicle. Slight irregularities not recognised as affecting the function or quality of the vehicle or parts such as slight noise or vibration and defects appearing only under particular or irregular operations or items considered characteristic of the vehicle.
7. This warranty shall be null and void if the vehicle is subjected to abnormal use such as rallying, racing or participation in any other competitive sports. This warranty shall not apply to any repairs or replacement as a result of accident or collision.
8. This warranty is expressly in lieu of all warranties, whether by law or otherwise, expressed or implied, and all other obligations or liabilities on our part and we neither assume nor authorise any person to assume on our behalf, any other liability arising from the sale of the vehicle or any agreement in relation thereto.
9. The buyer shall have no other rights except those set out above and have, particular, no right to repudiate the sale, or any agreement or to claim any reduction in the purchase price of the vehicle, or to demand any damages or compensation for losses, incidental or indirect, or inconvenience or consequential damages, loss of vehicle, or loss of time, otherwise, incurred or accrued.
10. Any claim arising from this warranty shall be recognised only if it is notified in writing to us or to our concerned dealer without any delay soon after such defect as observed and ascertained under this warranty.
11. This warranty shall stand terminated if the vehicle is transferred or otherwise alienated by the buyer without our prior written consent.
12. We reserve our rights to make any change or modification in the design of the vehicle or its parts or to introduce any improvement therein or to incorporate in the vehicle any additional part or accessory at any time without incurring any obligation to incorporate the same in the vehicles previously sold.

TATA MOTORS

REMOTE KEYLESS ENTRY (RKE) :

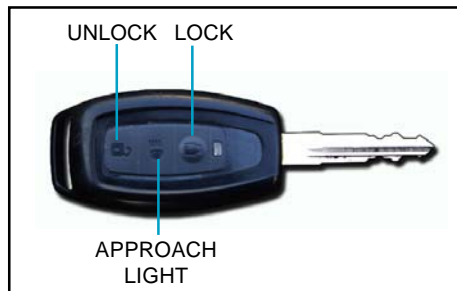

Your car is equipped with a Remote Keyless Entry (RKE) function.

The three buttons on ignition key are:

- 1) Unlock (To unlock the vehicle)
- 2) Approach / vehicle search Light
- 3) Lock (To lock the vehicle)

NOTE

- Do not leave your key inside the vehicle.
- The LED on the transmitter will flash to show that the E-Key is working.
- The operating of the E-Key's transmitter will vary due to environmental conditions.

Unlock :

Press once to unlock driver door & fuel flap. To open all doors including tailgate, press twice.

Lock :

Press once to lock all doors including tail gate and fuel flap.

Approach light :

When you want to search your vehicle, press approach light button on the key. The dip / Low beam, parking lamp and all interior lights of your vehicle will be switched ON.

If you press the approach button again or if you switch the ignition 'ON' immediately, the lights are switched 'OFF'.

In the absence of the above conditions, the lights go 'OFF' after approximately 30 seconds.

NOTE

If any of the E-Keys are lost, contact an authorised Tata dealer as soon as possible to de-activate the lost key.

Please note that spare original E-Key is required when making an additional E-Key.
If both the E-Keys are lost, please contact an authorised Tata dealer.

Changing E-Key Battery :



E- key after opening up of back screw

Low Battery Voltage status can be observed by User:

- a) Considerable reduction in the range of Remote
- b) LED on the Remote start to blink at faster rate when a button is pressed.

OPENING AND CLOSING DOOR

Front Doors (Driver and Co-driver):

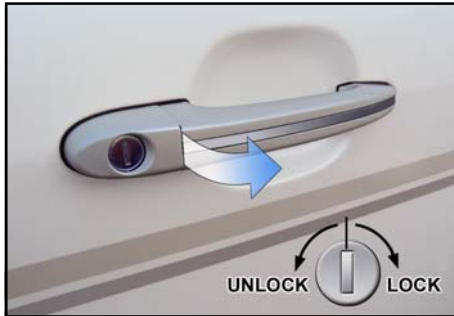

Locking / unlocking doors with key from outside:

Both front doors (drivers and co-driver) have separate locking facility. Front doors can be locked or unlocked from outside using the E-key.

Insert the E-key and turn it anti-clockwise to open or clockwise to lock the door. Pull the door handle to open an unlocked door.

Locking without a key from inside:



All the doors can also be locked or unlocked independently from inside by pressing or pulling the knob. **Press** to lock and **Pull** to unlock.

CAUTION

When locking doors this way, do not leave the key inside the vehicle.

You can also lock and unlock all the doors by the lock and unlock switches provided on the facia.

LOCK SWITCH : This switch is provided to lock the doors. By pressing the lock button all the doors can be locked.



UNLOCK SWITCH : This switch is provided to unlock the doors. By pressing the unlock button all the doors can be unlocked.



Opening the doors from inside:



All doors can be opened from inside. To open, pull the door opening lever.

NOTE

Do not leave the key inside the vehicle while closing the door.

Child lock:

Both the rear doors of the car are provided with a child lock. Push the lock lever located on vertical face of the door near the lock downward before closing the door. The door which has been locked by activating the child lock cannot be opened from inside, it can be opened only from the outside.

! CAUTION

Deactivate the child lock when not required.

Tail gate Locking / Unlocking:**1. Location of door handle**

The tail gate can be opened only from outside once the vehicle is unlocked. To unlock the vehicle, press the "UNLOCK" button twice on the RKE (Remote Keyless Entry) key. Once the vehicle is unlocked, pull the door handle (1) below the chrome garish on the tail gate. For locking the tail gate, press the "LOCK" button on the RKE key.

A seperate lock (2) is also provided on the tailgate. It can be operated by RKE key.

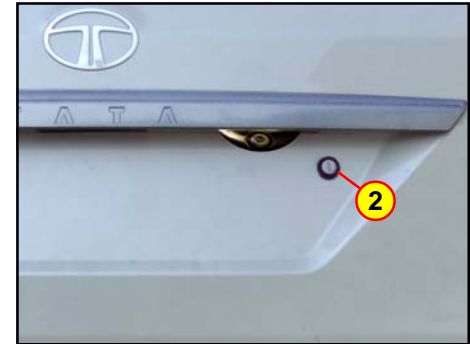
**2. Location of tailgate lock****NOTE**

Do not slam the tailgate. close smoothly for better performance.

Steering Lock and Ignition Switch :

Steering lock cum ignition switch is located on the right hand side of the steering column.

The key of ignition switch is common for door lock, steering lock and glove box lock. It has four positions. Turn the key clockwise to operate the below functions :

- LOCK** - Steering Locked
- ACC** - Accessories 'ON'
- ON** - All electricals 'ON'
- START** - Engine crank

NOTE**Illuminated key ring**

To assist you to locate your vehicle's ignition switch in the dark, the steering lock cum ignition switch comes with an illuminated key ring. When you open the driver's door, the illuminated key ring comes 'ON' and dims out when the door is closed after 60 seconds (similar to cabin lights).

LOCK:

You can insert or remove the key only in this position. The steering column is locked when the key is removed.

⚠ CAUTION

Do not remove the key while driving. It will lock the steering and can cause loss of control. Remove the key only when the vehicle is parked.

ACC (Accessories 'ON'):

When ignition key is turned to 'ACC' position, accessories like music system are switched 'ON'.

The engine can be turned 'OFF' without locking steering wheel by turning to 'ACC' position from 'ON' position.

ON:

In this position, all the electricals and accessories comes 'ON'.

STARTING THE ENGINE:

- Ensure that the vehicle is in Neutral gear for safe starting.
- Do not press the accelerator pedal.
- Wait till glow plug indicator goes OFF
- Keep the clutch pedal fully pressed and crank the engine. Release the key as soon as engine starts. While cranking, all accessories will be momentarily 'OFF'.

NOTE

The Starter Protection System fitted in this vehicle does not allow you to crank the engine until you fully press the clutch pedal.

SEATS :**Front Seats:**

1. *Seat Back Recliner Lever*
2. *Seat Height Adjustment Lever (Only on Driver's seat)*
3. *Lever for Forward and Backward movement*
4. *Lumbar support (Only on front seats)*

Bucket type seats are provided with multiple adjustments.

WARNING

Do not adjust the seat when driving.
Adjust the seat only when the vehicle is stationary.

1. Seat Back Recliner:

To change the seat back angle, lean forward slightly and raise the smaller lever. Keeping lever in raised position, lean back to the position you want and release the lever. Make sure that lever returns to it's original position.

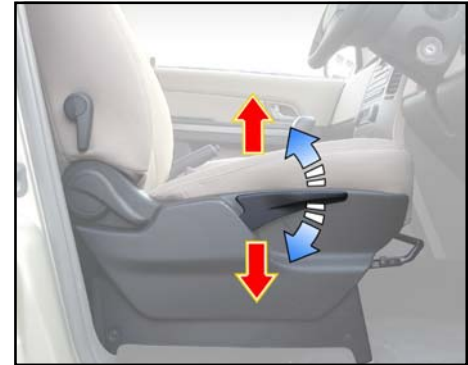
2. Seat Height Adjustment (Only for Driver's Seat):

Driver's seat height can be adjusted by a lever located on the seat base on the right hand side, just ahead of the seat back recliner lever. You can raise the seat height by pumping / pulling the lever upwards until appropriate seat height is reached and lower it by pumping / pushing the lever downwards.

3. Moving the Seat Forward and Backward:

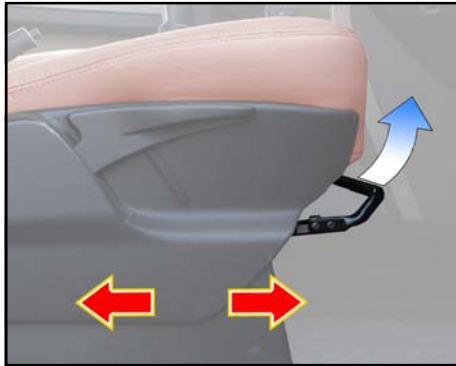

To adjust the seat position, lift the lever under the seat cushion front, slide the seat to the desired position and release the lever. Once the desired position is achieved, release the lever to lock the seat. Make sure the seat is locked firmly in position.

4. Lumbar Support (if fitted):



Lumbar support is provided on Driver and Co-driver's seats to give you comfort while driving. It is adjusted by the lever provided on the side of the seat backrest.

Front Seat Armrest (if fitted):



Front seats are provided with armrest. For folding the armrest, pull the knob upwards fitted to it and lift the armrest.

NOTE

If you feel inconvenience while driving, always keep the armrest in foldable position.

Second Row Seat :

Second row seat is split in 2 parts (60:40). Space for two occupants is provided at RH side and space for single occupant is provided at the LH side.

Foldable Armrest (if provided) :

A foldable arm rest has been provided in the second row seat. This can be used by the occupants for resting their arms. It also has two cup holders and a utility box, which can be accessed by opening the cover. When not required, this armrest can be folded back into the seat.

NOTE

Never use armrest as a support.
Never allow children to sit on armrest.

Moving the Seat Forward and Backward:***Lever for Forward and Backward movement***

To adjust the seat position, lift the lever under the seat cushion front, slide the seat to the desired position and release the lever. Once the desired position is achieved, release the lever to lock the seat. Make sure the seat is locked firmly in position. Both second row seats can be adjusted independently.

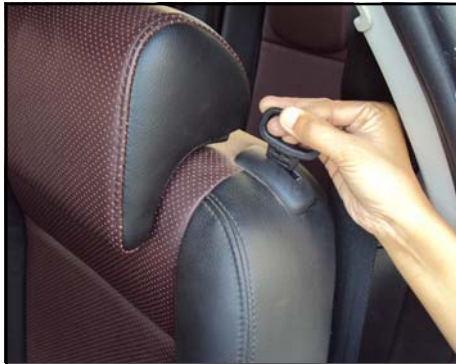
Second Row Seat Folding :***Plastic hook for folding seat backrest***

These seats can be independently folded, as & when required for carrying long objects. The seat backrests are provided with a plastic hook for folding at seat back. Pulling the plastic hook upwards allows the seat backrest to fold.

To incline the seat to a desired angle, pull the plastic hook upwards, set the angle and release the hook for locking.

For keeping the seat backrest upright, push back the seat backrest until it gets locked in its position.

Front Facing Third Row Seat :

A foldable and split type soft cushioned comfortable seats are provided at the rear behind the second row seat.

Third Row Seat Folding :***Fabric hook for folding seat backrest***

A fabric hook is provided behind the seat backrest. To fold the seat, pull the fabric hook. Both the seats can be independently folded to create extra luggage space.

For keeping the seat backrest upright, push back the seat backrest until it gets locked in its position.

Getting in and out Third Row Seat :

To get in/out, you have to fold any of the 2nd row seats. To fold the this seat :

1. Pull the plastic hook located on top of the middle seat backrest. The seat back rest collapses.



Plastic hook for folding seat backrest

2. Now lift the seat from its base by pulling the knob provided at the base of the seat to fold.



The second row seats can also be lifted from its base by pulling the fabric hook located behind the seat's back.

**NOTE**

While folding the second row seat after getting inside the third row seat, never keep your feet on the seat locking brackets.

For instructions please refer the sticker attached at the bottom side of the second row seat.



Getting extra luggage space:

Extra luggage space can be created by folding either second or third row seat based on your requirement.

NOTE

When folded, each seat base can carry a load of approximately 25 Kgs.

A flap is provided on third row seat to bridge gap between second and third row seats, when fully folded. The flap can withstand max. 5 kg. of load.



Location of flaps



Luggage space after folding third row seat



Luggage space after folding second and third row seat

Parcel Shelf fitment provision :



Your vehicle has a provision for fitting a parcel shelf over third row seat.

To fit the parcel shelf, fold the third row seat and slide both the parcel shelf mounting covers upwards. Fix the parcel shelf and ensure for proper locking.

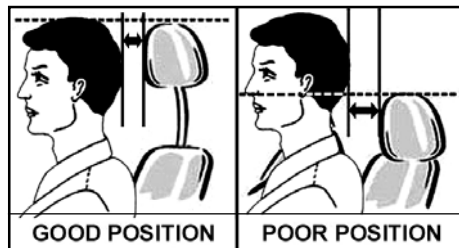
Head Restraint:

Head restraints are designed to help in reducing neck injury in case of accidents. For best protection, adjust the head restraint, so that it is in the level with one's ears.

To adjust the head restraint, pull or push it until it clicks. If head restraint needs to be removed, pull the head restraint fully upwards, then push the notch button with a thumb.

WARNING

Avoid driving the vehicle with the head-restraint removed as it is provided for your safety.

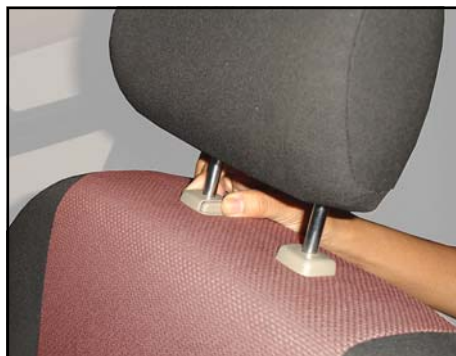
*Notch button***SEAT BELTS**

Your vehicle is equipped with seat belts, for front and rear seats as a part of occupant restraint system.

Wearing seat belts properly can protect you from being thrown against the insides of the vehicle or against other occupants in case of an accident or sudden braking. It will reduce the chances of severe injury.

This vehicle has three point inertia reel type front and rear seat belts in the out board positions and a lap belt for middle passenger on second row rear seat. In normal driving, the belt lets you move freely in your seat. In case of an accident or sudden braking, inertia reel automatically tightens the belt to help restrain your body.

The anchor end of the shoulder belt is adjustable to suit the height of the passenger wearing it. The lap belt has one manually adjusted belt that fits across the hip bone. Make sure that your

seat is adjusted to a good driving position and the back of the seat is upright.

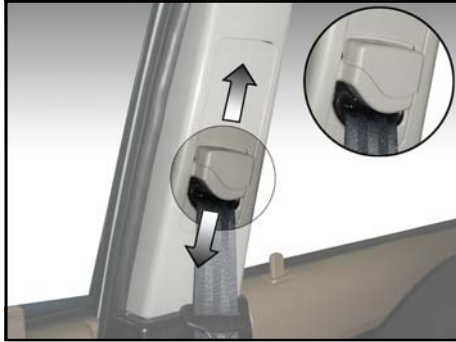

Seat belt height adjustment

Retractor Pre - tensioner Load Limiter belts (RPLL) :

The main function of RPLL belt is to remove slack from the belt in the event of an accident to restrict forward movement of the occupant. The RPLL belts are triggered in situations where the front or side airbags deploy. **Do not disconnect RPLL belts electrical connection.**

How to use shoulder / lapbelts :



1. Seat Belt
2. Tongue

3. Lock Buckle
4. Lap Belt

- Enter the car and close the door. Sit back and adjust the front seat. Make sure that your seat is adjusted to a good driving position and the back of the seat is upright.
- The tongue is located above the back of your seat. Grasp the tongue and pull out the belt over the shoulder and across the chest. When the belt is long enough to fit, insert the tongue into the lock buckle until you hear a “CLICK” which indicates that the belt is securely locked.

- Position the lap belt across your thighs, below your abdomen. To remove slack in the lap belt portion, pull up a bit on the shoulder belt. To loosen the lap belt if it is too tight, tilt the tongue and pull on the lap belt. A snug belt reduces the risk of sliding under the belt in a collision.
- To release the belt, push the red button on the lock buckle. The belt will automatically retract to its stowed position. If necessary, slide the tongue down the webbing to allow the belt to retract fully.

Seat belt safety :

WARNING

- Wearing a seat belt incorrectly is dangerous. Seat belts are designed to bear upon the bony structure of the body and should be worn low across the front of the pelvis, or the pelvis, chest and shoulders, as applicable. Wearing the lap section of the belt across the abdominal area must be avoided.

- Each belt assembly must only be used by one occupant. It is dangerous to put a belt around a child being carried on the occupant's lap.
- A belt that is buckled into the wrong buckle will not protect you properly. Always buckle your belt into the buckle nearest you.
- A belt that is too loose will not protect you as well. In a sudden stop, you could move too far forward, increasing the possibility of injury.
- A belt that is worn under your arm is very dangerous. Your body could strike the inside surfaces of the vehicle in a collision. Wear the belt over your shoulder.
- Be sure the belt is straight. If you can't straighten a belt, take it to your nearest TATA authorized dealer.
- A frayed or torn belt could rip apart in a collision and leave you with no protection. Inspect the belt system

periodically, checking for cuts, frays, or loose parts. Do not disassemble or modify the system.

- If possible, use the seat belts to secure heavy luggage that are to be carried on the seats.
- Do not wear seat belts over hard, sharp or fragile items in clothing, such as pens, keys, spectacles etc.
- Care should be taken to avoid contamination of the webbing with polishes, oils and chemicals especially battery acid. Cleaning may safely be carried out using mild soap and water.

Seat belt warning indicator :

Seat belt warning indicator  comes 'ON' for 3 seconds followed by blinking with buzzer for 6 seconds, when ignition is turned 'ON' .

If seat belt is not fastened, the lamp will be 'ON' continuously without audio alarm till vehicle speed reaches 16 km/h.

When vehicle speed exceeds above 16 km/h, the lamp will continue to flash with intermittent audio alarm.

Once the seat belt is fastened, the buzzer and warning indicator will go 'OFF'.

Use of seatbelts for expectant mother:



Expectant mother must wear a correctly positioned seat belt. It is safer for mother as well as unborn child. Doctor's advice is recommended.

Expectant mother should wear the lap part of the belt across the thighs and as

snug across the hips as possible. Keep the belt low so that it does not come across the abdomen. That way the strong bones of the hips will take the force if there is a collision.

Child restraints:



For optimum safety, children should travel in the rear of the vehicle at all times. However, if it is essential that a child travels in front, set the front passenger seat fully backward and disable the passenger air bag using the switch on the side of dash board at the passenger's side.

Use only approved Child restrained system which meets safety standards. Only fit a child seat that has been approved for use in your vehicle and ensure that the manufacturer's fitting instructions are followed correctly.

Seat belt parking brackets :

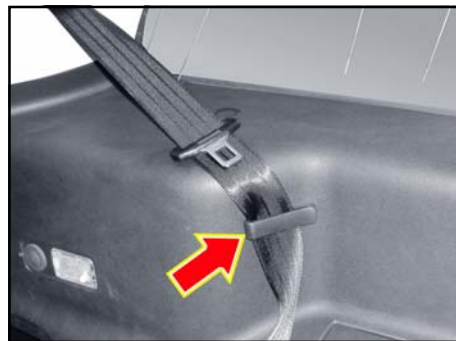

Your vehicle is provided with seat belt parking brackets for second and third row seat belts. Whenever second or third row seat is not occupied, hook the seat belts at its respective parking brackets to avoid rattling.

REAR VIEW MIRRORS :
Inner Rear View Mirror :



1. Inner Rear View Mirror 2. Anti-glare Knob

Inner rear view mirror is mounted inside the cabin near the front cabin lamp. It has two positions:

- a. Normal position
- b. Antiglare position

NOTE

Use Antiglare position only when necessary, as it reduces rear view clarity.

Power Fold and Motorised Outer Rear View Mirror (if fitted):



Motorised Rear View Mirrors are fitted on both front doors and can be adjusted to the desired position with the help of a switch provided on the driver side door.

Motorised Rear View Mirrors allow the driver to adjust the mirrors without lowering the glasses and without moving from his position.

1. Move the main switch to L (for left side) and R (for right side)
2. Use the 4 positions of the knob to



1. Mirror Adjustment Switch 2. Mirror Selection Switch 3. Mirror Fold Switch

adjust the rear view mirrors to required position.

These mirrors are provided with demister. For activating the rear view mirror demister and rear windshield demister, a common switch is provided on the A.C. panel. Outer rear view mirrors can be folded by operating the mirror fold switch (3). This enables you to park your car in limited parking space. Press the mirror fold switch to fold both outside mirrors simultaneously. Press again to unfold.

Steering wheel position Adjustment

1. Unlock Position 2. Lock Position

You can adjust the steering wheel position to suit your convenience.

Adjust the steering wheel position as follows before you start driving.

1. Adjust the seat to the comfortable position.
2. The lever to tilt the steering wheel is under steering column. Push the lever to unlock the steering column.

3. Move the steering wheel up or down to the desire position. Position the wheel such a way that all the instrument panel gauges and warning lights are visible.
4. Pull the lever to lock the steering column once steering column position is fixed. Make sure that steering wheel is securely locked by moving up and down.

⚠ CAUTION

Steering wheel should be adjusted only when the vehicle is stationary.

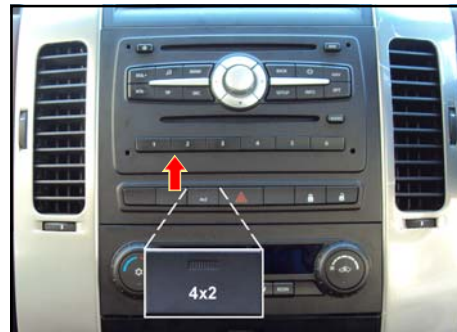
4 X 2 and 4X 4 / AUTO mode selection switch :

To activate 4 X 2 mode, press “4 X 2” switch provided on your vehicle’s facia, the **LED** on the switch turns “**ON**”.

To activate **4 X 4 / Auto mode**, again press “4 X 2” switch provided on your vehicle’s facia, the **LED** on the switch goes “**OFF**”.

Master Light Switch:

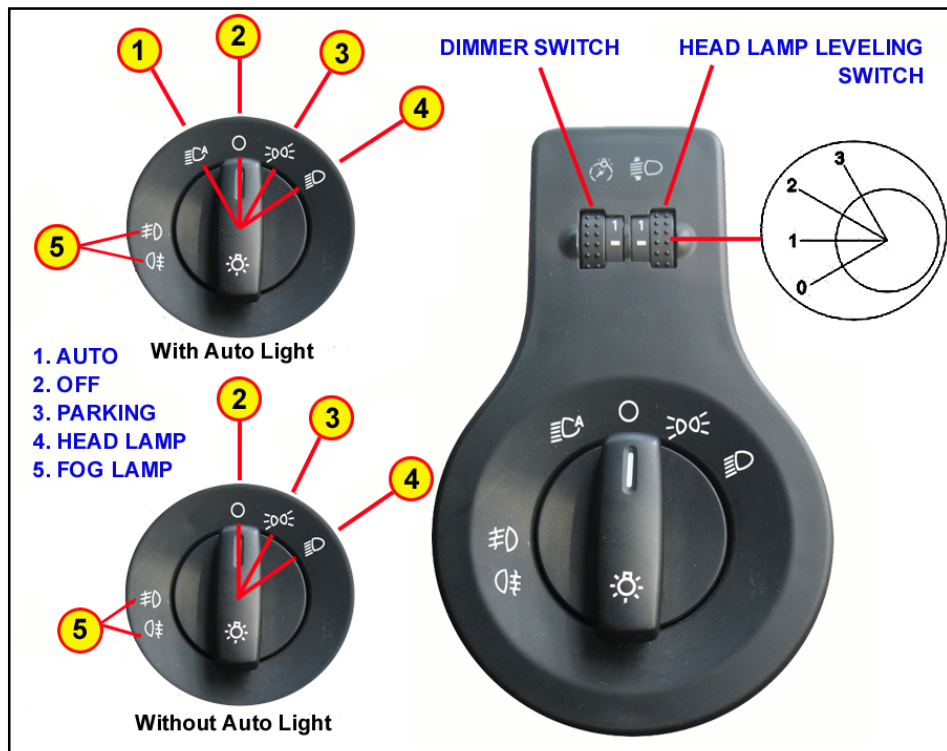

The Master Light Switch is located on the right of the steering wheel on the dashboard.

Knob functions :

1. Auto Light (if fitted) : In this position, the headlights will be automatically switched ON depending on ambient light conditions (while entering a tunnel or when it is twilight). **For details, please refer - SPECIAL FEATURES - Rain & Light sensors.**

2. OFF : In this position, all functions are 'OFF'.

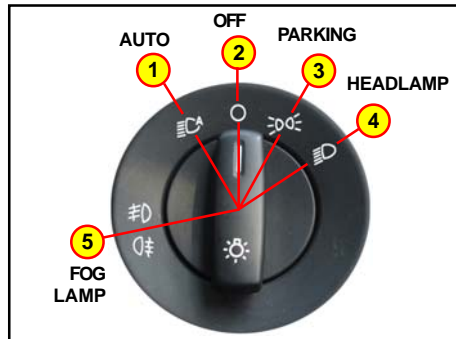

3. Parking : In this position, only Parking lamps are switched 'ON'.

4. Headlamp : In this position, Head lamps and Parking lamp are switched 'ON'.

5. Fog Lamp : For switching 'ON' the Fog lamps, either the Head Lamp or Parking lamp must be 'ON'. Therefore turn the knob to position 3 or 4.

The knob can be pulled / pushed in two positions to turn 'ON' / turn 'OFF' the fog lamps. First pull will turn 'ON' the front fog lamps and second pull switches 'ON' the rear fog lamps. Similarly the

first push will switch 'OFF' the rear fog lamps and second push will turn 'OFF' the front fog lamps.

NOTE

Use fog lamps in foggy / misty conditions to improve visibility.



Front fog lamp - Switch 'ON' position



Rear fog lamp - Switch 'ON' position

Adjusting the Headlamp:

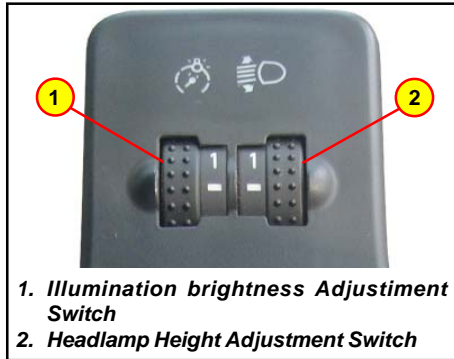

The Master Light switch also has Head lamp leveling function. You can adjust the headlamp beam depending on load (passengers / goods) in your car.

This can be operated by a scroll type switch located above the Master light switch knob.

NOTE

When the low beam is switched ON, adjust the headlamp range to suit the car load. Adjust when vehicle is stationary.

Loading Condition	Switch Position
Unladen	0
One Person in the driver's seat	
One Person in the driver's seat + One in the front passenger seat	
One Person in the driver's seat + One in the front passenger seat + Two people in the rear most seat	1
All seats occupied (7 People)	2
All Seats occupied + Luggage area filled to permissible axle load	3
One Person in the driver's seat + Luggage area filled to permissible axle load	

Adjusting the illumination brightness:

The function of Illumination control switch (Scroll type) is located above the Master light switch knob to vary the brightness of backlit illumination of devices and switches in the cabin.

Power Windows :

1. *Rear Power Window Lock / Unlock Button*
2. *RH Front Window Winding Switch*
3. *RH Rear Window Winding Switch*
4. *LH Front Window Winding Switch*
5. *LH Rear Window Winding Switch*

Glasses on all four windows of your vehicle can be operated by switches provided on the main control panel located at driver's arm rest. They work only when the key is in the "IGN" position. Each window glass can be operated with switch provided on other doors.



Window Winding Switch on rear doors

Glasses are wound up by pulling the switch and are lowered by pressing it down. If you would prefer to have the glass at its lower most position, press the switch down and the glass glides down. This feature is known as "Express Down".

A safety locking arrangement has also been provided and can be activated by a push type switch located at the centre, below the window switches. It has two positions:

PRESS - 'ON' Position

Again PRESS TO RELEASE - 'OFF' position

When the switch is in "LOCK" position, the rear window switches (located on rear doors) do not function. The rear window glasses can still be operated by using the switches on the console. Illumination on the rear window switch goes off when the switch is in locked condition. Press down the lock button to unlock.

Individual window winding switches have been provided only on other doors.

WARNING

While raising the glass, take care to avoid fingers / hands getting trapped between glass and the frame.

DASHBOARD

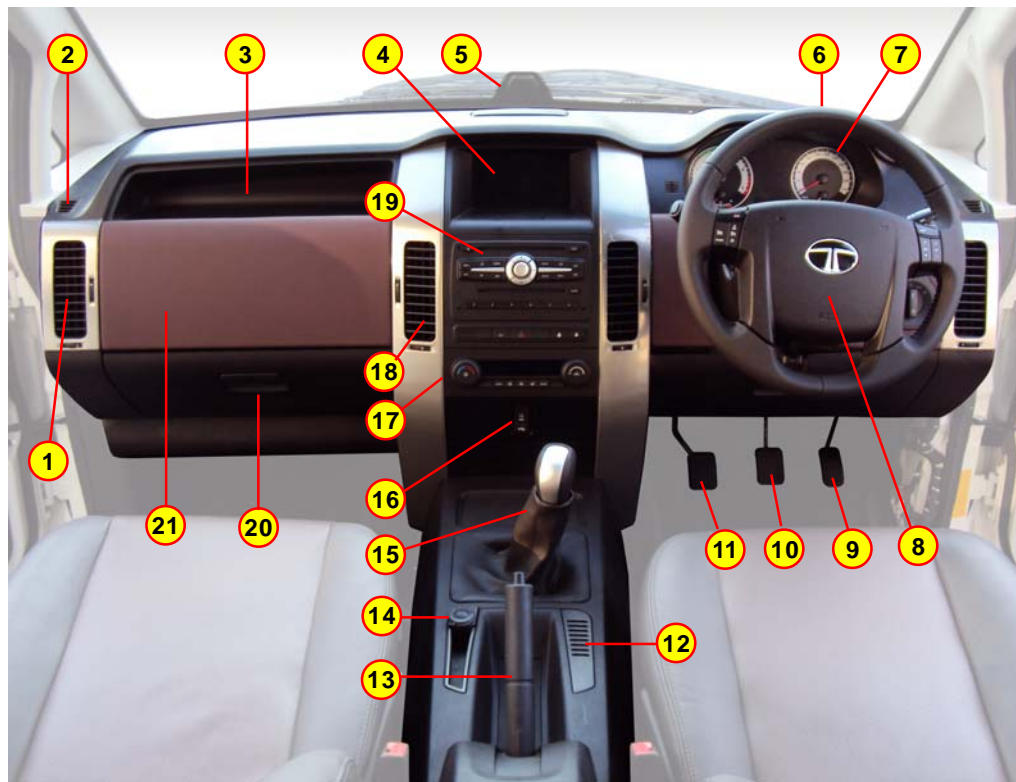

- | | |
|-----|-----------------------------------|
| 01. | Side A.C. Vents |
| 02. | Side A.C. Vents |
| 03. | Top Stowage Box |
| 04. | Display Monitor |
| 05. | Rain Light Sensor |
| 06. | Steering Wheel |
| 07. | Instrument Cluster |
| 08. | Horn Pad |
| 09. | Accelerator Pedal |
| 10. | Brake Pedal |
| 11. | Clutch Pedal |
| 12. | Coin Holder |
| 13. | Parking Brake |
| 14. | Power Socket |
| 15. | Gear Shift Lever |
| 16. | USB / AUX port |
| 17. | HVAC Control |
| 18. | A.C. Vents |
| 19. | Music System |
| 20. | Glove Box |
| 21. | Glove Box (With Cooling facility) |

Gearshift lever & Shifting pattern :



The gearshift lever is mounted on the central console between the two front seats. The gearshift pattern is shown on the gear lever knob.

CAUTION

The reverse gear should be engaged only when the car is stationary. Wait for 5 seconds after declutching to ensure smooth engagement of the reverse gear.

Parking brake :

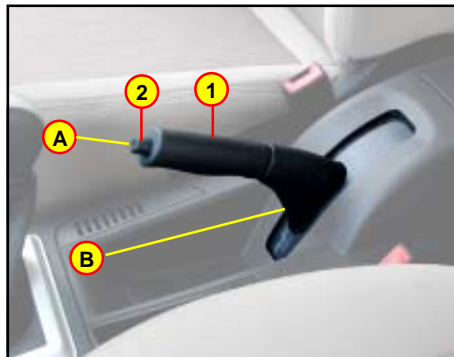

1. Parking Brake Lever 2. Release Button
A. Parking Brake Applied Position
B. Parking Brake Released Position

A mechanical parking brake acting only on the rear wheel is provided on your vehicle. The parking brake lever is located behind the gearshift lever. To apply the parking brake, pull the lever up fully. The indicator light (ⓘ) on the instrument panel will come 'ON'.

To release it, pull the lever up slightly, press the release button and push the lever down. The parking brake indicator

(ⓘ) on the instrument panel will go 'OFF' when the parking brake lever is fully released. When parking on level ground, place the gear lever in the 'Neutral' position. When parking on a downhill gradient, place the gear lever in 'Reverse' position. When parking on uphill gradient, place the gear lever in the '1st' position.

CAUTION

Apply the parking brake properly before leaving the car & release it before moving. Use the parking brake for holding the car on a gradient.

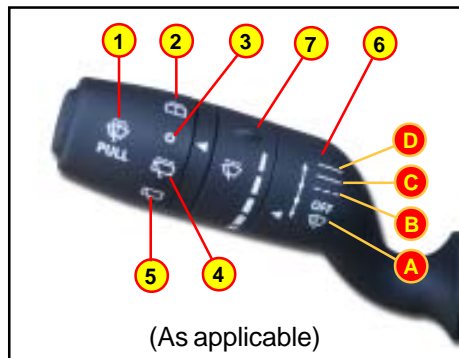
COMBI-SWITCH (LH STALK) :**1. Front windshield wash and wipe :**

To spray the washer fluid on the windshield.

1. When you pull the lever little longer, washer fluid will be sprayed on the windshield.
2. The windshield wipers operate for three cycles after the lever is released and one more cycle after five seconds.
3. When you crank the car's engine, the supply to washer motor is briefly cut off.

WARNING

If you operate wash and wipe function for more than 30 seconds the controller cuts off the supply to washer motors to avoid overheating.

2. Rear windshield wash and wipe :

Turn and hold the rotary knob to operate rear windshield wash and wipe. It will return to 'OFF' position as soon as released.

3. OFF position**4. Rear intermittent wipe :**

Turn the rotary knob and align (4) position with arrow mark to operate rear intermittent wiper. Rear wiper will start wiping intermittently.

5. Rear wiper continuous 'ON'

Turn the rotary knob and align (5) position with arrow mark to operate rear intermittent wiper. Rear wiper will start wiping continuously.

6. Front windshield wipe and wash :

A) Flick / Mist : To operate front windshield wiper in case of light-rain or mist, move the lever downward

slightly and release. It will return to 'OFF' position. The wiper will operate once.

B) Intermittent wipe : To operate intermittent wipe, lift the lever to position 'B'.

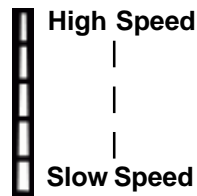

By rotating rotary switch (7), you can select desired wiper speed.

C) Slow wipe : To select 'SLOW' continuous wipe, lift the lever to position 'C'.

D) Fast wipe : To select 'FAST' continuous wipe, lift the lever to position 'D'.



(As applicable)

Auto front wipe:

If your car comes fitted with a Rain and Light Sensor, Auto Front Wipe is activated only when the wiper stalk is in the Auto position. (Cars having Auto Front wipe will not be fitted with an intermittent wipe speed selector).

Other operations of the switch are same as explained on previous page except intermittent front wipe.

For details, please refer 'SPECIAL FEATURES - Rain and Light sensors'.

NOTE

Turn the ignition switch to 'ON' position, to operate all wash and wipe functions.

All functions pauses temporarily, when the engine is being cranked and resumes it's function once cranking is complete.



Front windshield washer nozzle

⚠ CAUTION

1. Do not operate the windshield wipers, when the windshield is dry or obstructed.

2. Always check and top up the windshield washer fluid in the container.
3. Get the front and rear washer nozzles cleaned periodically.

COMBI-SWITCH (RH STALK) :



(As applicable)

Turn Signals :

Right turn signal :

Right indicator lamps and instrument cluster tell tale will come 'ON' if ignition is 'ON' and indicator stalk is moved to

downward. For changing lanes, lightly flip the stalk downwards.

Left turn signal :

Left indicator lamps and instrument cluster tell tale will come 'ON' if ignition is 'ON' and indicator stalk is moved to upward. For changing lanes, lightly flip the stalk upwards.

Flash function :

Pull the lever towards steering wheel to flash the hi-beam head lamps and it will remain 'ON' till lever is in pulled position. The lever will return to it's original position after releasing the lever.

Hi-Beam :

To switch over head lamps to hi-beam :

- ◆ Master light switch to head lamp position.
- ◆ Push the lever towards instrument cluster.
- ◆ Hi-beam headlamps and instrument cluster tell tale will come 'ON'.

To switch over from high beam to low beam, PULL the lever back towards the steering wheel.

TRIP, FUEL, SET functions :

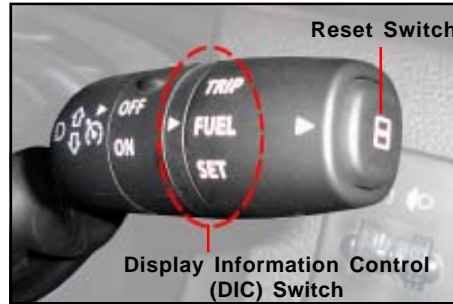

By rotating the outermost ring of the Combi Switch, you can set the TRIP, FUEL and SET functions that are displayed on the instrument cluster. To reset/ scroll the values of the Trip meter, press the outermost switch on the stalk. **(Please refer to Instrument Cluster section to know more about these functions).**

Cruise master ON / OFF switch :

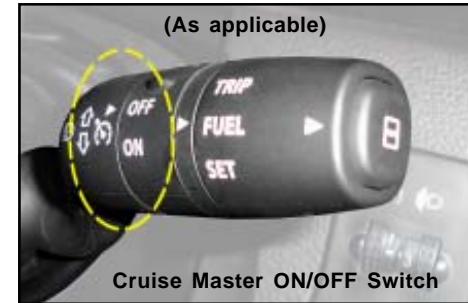

If you want your vehicle to maintain a particular, constant speed, rotate knob on the right stalk to 'ON' position to activate the cruise function. This function is controlled by the Steering Wheel switches. **(Please refer to Cruise Control section for details).**

INSTRUMENT CLUSTER

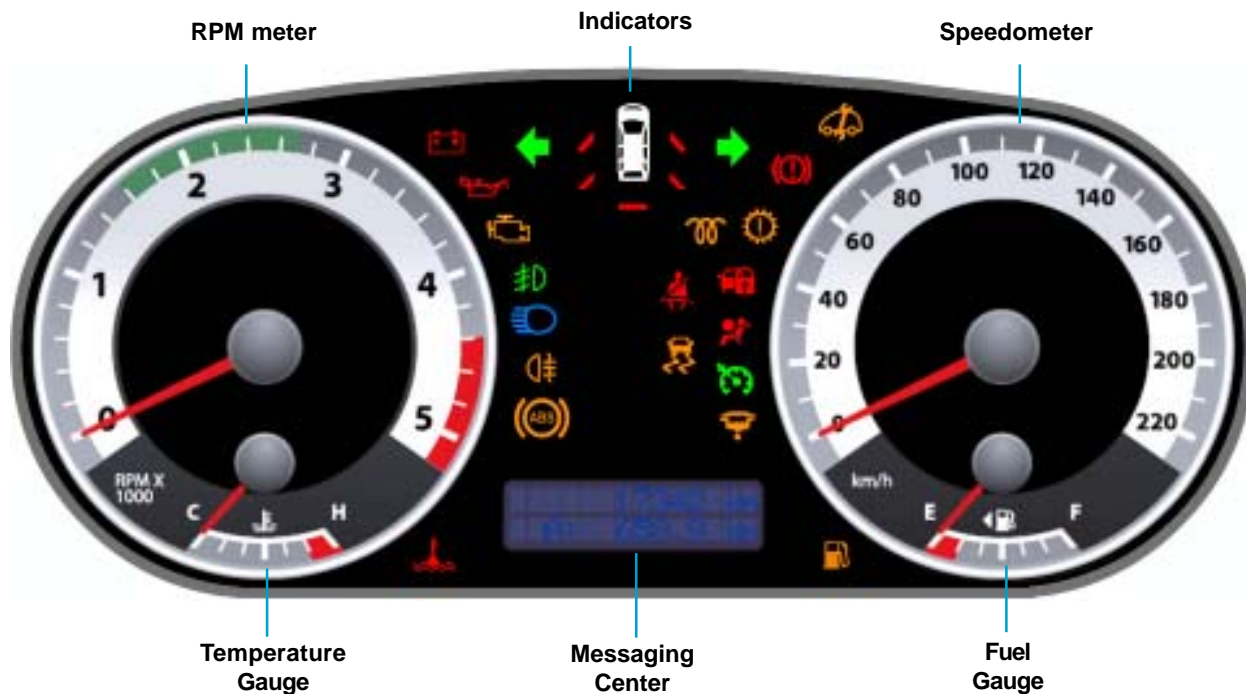

Instrument Cluster :









The Instrument cluster consists of Speedometer, RPM Meter, Temperature gauge and Fuel gauge.







The instrument cluster also houses the Message Centre. It consists of :











- 1) Main Odometer
- 2) Trip meter (Distance for two trips - A & B can be measured)
- 3) Fuel Computer. Fuel Computer displays :
 - a) Instantaneous Fuel consumption
 - b) Average Fuel Consumption (For trips A & B)
 - c) Range (Distance to Empty)
(Distance that can be covered with the amount of fuel in the tank)
- 4) Outside Ambient Temperature

In addition to the above, the instrument cluster displays the Tell Tales and “Warning Messages” and “Trip” switches.

Instrument cluster - Tell tales

TELL TALES	COLOUR	SYMBOL	PRE-CHECK	BUZZER ENABLED	TEXT ON DISPLAY WITH PRIORITY
Turn Indicator	Green		X	√	X
High Beam	Blue		X	X	X
Battery Charging	Red		√	X	X
TOD/Transmission fault	Amber		√	X	X
Park Brake Applied	Red		√	X	PARK BRAKE ON (H)
Brake Fluid Oil level low					BRAKE FLUID LOW (H)
EBD signal from ABS ECU					EBD FAULT (H)
Glow plug indicator	Amber		√	X	X
Malfunction Indication Lamp	Amber		√	X	X
			√	X	X
Service Lamp Indicator	Amber		√	X	X

TELL TALES	COLOUR	SYMBOL	PRE-CHECK	BUZZER ENABLED	TEXT ON DISPLAY WITH PRIORITY
Low Engine Oil Pressure	Red		√	X	X
Low Fuel warning	Amber		√	X	X
High Temperature Warning	Red		√	√	X
Water In Fuel (Diesel)	Amber		√	√	X
ABS	Amber		√	X	X
Airbag	Red		√	X	X
Traction Control System Failure	Amber		√		TCS FAULT (H)
Traction Control System Switched Off					TCS SWITCHED OFF (H)
ESP System Failure					ESP FAULT (H)
ESP System Switched Off					ESP SWITCHED OFF (H)

TELL TALES	COLOUR	SYMBOL	PRE-CHECK	BUZZER ENABLED	TEXT ON DISPLAY WITH PRIORITY
Seat Belt	Red		√	√	FASTEN SEATBELT (H) - Only for Export
Immobilizer	Red		X	X	X
Front Fog	Green		X	X	X
Rear Fog	Amber		X	X	X
Driver Door open	Red		X	X	X
Co-Driver Door open	Red		X	X	X
Rear Left Door open	Red		X	X	X
Rear Right Door open	Red		X	X	X
Tail gate open	Red		X	X	X
Cruise Control	Green		√	X	X

Tell Tales Description**Turn Signal:**

One of these symbols comes 'ON' when the turn indicators is switched 'ON'. Turn signal lamps can be operated only when the ignition supply is 'ON' and by using the turn indicator switch on the combi-switch. The direction indicator arrow (LHS) and (RHS) on the instrument cluster flashes along with external indicator lights as selected.

If one of the external indicator bulbs gets fused, it is indicated by high frequency flashing of the bulb of the same side.

High Beam:

This symbol comes 'ON' when the headlamp high beam is switched 'ON'.

Battery charging:

This symbol lights up when the 'IGN' is turned 'ON' and should go 'OFF' after the engine starts.

NOTE

If it remains 'ON' while the engine is running, it indicates that the battery is not getting charged. Switch off all unnecessary electrical equipment and get the problem attended to at TATA Authorised Service outlet.

TOD Indicator :

This symbol comes 'ON' when the ignition is turned ON and goes 'OFF' after approximately three seconds. If it continues to remain 'ON' or if it comes 'ON' after Ignition on precheck, it indicates a fault in the Transmission system. Take your car to a TATA Authorised Service centre.

Park Brake / Brake Fluid Oil level Indicator:

This indicator comes 'ON' for approximately three seconds when ignition is turned 'ON' and goes 'OFF'. If it remains 'ON', it may indicate :

1. Brake fluid level is low.
2. Parking brake is applied. It will go 'OFF' when it is released.
3. Fault in ABS/EBD system

Diesel Pre-Heat indicator / Glow Plug Indicator:

This symbol comes 'ON' when the ignition key is in the 'ON' position.

NOTE

Engine should be started only after this indicator goes 'OFF'.

Malfunction Indication Lamp:

This symbol comes 'ON' when the ignition is turned 'ON' and goes 'OFF' after 3 seconds.

CAUTION

This symbol will remain 'ON' for any engine related fault that may cause increase in emission levels of the car beyond the regulatory limit. Take your car to a TATA Authorised service centre.

Low Engine Oil Pressure Indicator:

When the ignition is turned 'ON', this symbol lights up and goes 'OFF' as soon as the required engine oil pressure is developed after starting the engine.

WARNING

If the low oil pressure indicator does not glow or remains 'ON' with the 'IGN' 'ON' and engine is running, it indicates a fault in the electrical circuit / lubrication system. Take your car to a TATA Authorised Service centre.

Low Fuel Indicator:

This symbol lights up when ignition is turned 'ON'. The symbol lights up continuously if fuel level in the tank is low. Fuel needs to be filled immediately. It will blink if there is any fault in the system. Take your car to the nearest Tata authorized service station if the symbol starts blinking.

High Temperature Warning:

This symbol lights up when the ignition is turned 'ON'. If the engine is overheating, this indicator blinks along with a audible buzzer. At this stage, take the car to the nearest Authorised Service outlet. This symbol blinks and audible buzzer sounds simultaneously when engine coolant temperature is more than normal.

WARNING

Never remove the radiator pressure cap from the radiator when the engine is hot. Do not restart the engine until the problem has been duly attended.

Water in fuel indicator:

This symbol indicates excess water accumulation in the sedimenter. It will come 'ON' when ignition is turned 'ON' and will go 'OFF' in approx. 3 seconds. When this lamp remains 'ON' and a buzzer is sounded, water needs to be drained from sedimenter immediately.

CAUTION

If water is not drained from the sedimenter, it can cause serious damage to the fuel injection system.

ABS Indicator:

When ignition is turned 'ON', this symbol comes 'ON' for three seconds and goes 'OFF'.

This symbol will continue to remain 'ON' or will come 'ON' after Ignition On precheck if there is a problem in the ABS system.

Airbag Indicator:



The air bag warning symbol comes on for approximately 3 seconds when the ignition is turned 'ON' and goes 'OFF'.

WARNING

If it remain 'ON' or blinks, take your car to the nearest Tata Authorised Service Centre.

Traction Control / ESP Indicator :



This symbol comes 'ON' when ignition is turned 'ON' for approximately three seconds and goes 'OFF'. This symbol continues to remain 'ON' if there is a fault in the system. Take your vehicle to the nearest Tata Authorised Service Centre at the earliest.

Seat Belt Indicator:



Seat belt warning indicator comes 'ON' for 3 seconds followed by blinking with buzzer for 6 seconds, when ignition is turned 'ON'.

If seat belt is not fastened, the lamp will be 'ON' continuously without audio alarm till vehicle speed reaches 16 km/h.

When vehicle speed exceeds above 16 km/h, the lamp will continue to flash with intermittent audio alarm.

Once the seat belt is fastened, the buzzer and warning indicator will go 'OFF'.

Immobiliser Warning Indicator :



This symbol is of a system that disables engine starting if you do not use the original key. The user has to use original key for authentication and unlocking the car. Refer to Immobiliser section for details.

Lamp Blink: Car is in immobilised condition when key is not inserted.

Lamp OFF: Normal condition (Authenticated user) and engine will start.

Lamp ON: Problem with key/system. Take your car to TATA Authorised service centre.

Front Fog Lamp :



This symbol comes ON when the Front Fog lamp is 'ON'.

Rear Fog Lamp:



This symbol comes 'ON' when the Rear Fog lamp is 'ON'.

Service Lamp Indication



This symbol comes ON when ignition is turned ON & goes OFF after 3 seconds.

It remains ON if there is any problem in Engine Management system / engine related components.

CAUTION

If service lamp remains ON when engine is running, the engine's performance may get deteriorated. Take your car to a TATA authorized service centre.

Driver Door Open Warning:

If the Driver's door is open or not properly closed, this symbol comes 'ON' once the ignition key is inserted. Please ensure all the doors are properly closed before you start driving.

Co-Driver Door Open Warning:

If the Co-Driver's door is open or not properly closed, the corresponding door open indicator will come 'ON'. Please ensure all the doors are properly closed before you start driving.

Rear Left Door Open Warning:

If Rear Left Door is open or not properly closed, the corresponding door open indicator will come ON. Please ensure all the doors are properly closed before you start driving.

Rear Right Door Open Warning:

If Rear Right Door is open or not properly closed, the corresponding door open indicator will come ON. Please ensure all the doors are properly closed before you start driving.

Tail Gate Open Warning:

If Tail Gate is open or not properly closed, the corresponding door open indicator will come ON. Please ensure all the doors are properly closed before you start driving.

Cruise Control:

This comes ON for approx. 3 seconds when ignition is turned ON.

This symbol comes ON when you activate / switch ON the Cruise Control. (Please refer to Cruise Control section for working of Cruise Control).

Audible Warnings:

If any one of the conditions mentioned below occurs, a buzzer is also sounded.

Conditions when Buzzer comes ON:

1. Driver Seat Belt is not fastened (refer Seat Belt warning description).
2. Key-in Ignition and Driver Door is open.
3. Key taken out, Parking lamp is 'ON' and Driver Door is open.
4. Engine Coolant Temperature is high.
5. Water in Fuel.
6. Turn Indicator (Left or Right) is 'ON' or Hazard is 'ON'.

INSTRUMENT CLUSTER - MESSAGING CENTRE

Sr. No.	Parameter	Characteristics
1	Multifunctional Display	Colour: Blue Text with Black back ground
2	Main Odometer	Range : 0 to 999999 Resolution : 1 km The Odometer reading does not over flow to "0.0" when maximum value is reached, the display will freeze to maximum value. 999999 km
3a	Trip Meter (A&B)	Range : 0.0 to 9999.9 (5 digits) Resolution : 0.1 km Trip meter reading becomes "0.0" after it crosses 9999.9 kms. A: 9999.9 km B: 9999.9 km

Sr. No.	Parameter	Characteristics
3b	Trip meter reset	Trip meter (A & B) are reset by pressing "Trip" switch when the particular Trip-meter is selected DIC switch should be in "Trip" mode.
4	Fuel Computer - Instantaneous Fuel Consumption	Range : 0.0 to 99.9 (3 digits) Resolution : 0.1 km/l or L/100km INST FUEL 99.9 km/l INST FUEL 99.9 L/100km
5	Fuel Computer - Average Fuel Consumption (A & B)	Range : 0.0 to 99.9 (3 digits) Resolution : 0.1 km/l or L/100km AVG FUELA AVG FUELA 99.9 km/l 99.9 L/100km AVG FUEL B AVG FUEL B 99.9 km/l 99.9 L/100km

Sr. No.	Parameter	Characteristics
5	Average Fuel Consumption reset	When Trip meter "A" or "B" is reset, the Average Fuel Consumption "A" or "B" for that particular Trip meter also will get reset. Display Information Control (DIC) switch should be in 'Trip' mode.
6	Fuel Computer - Range (Distance to Empty)	Range : 0 to 999 RANGE 999 KM
7	Out side Ambient Temperature	Range : -199 to +199 (2 1/2 digits, Leading zero's shall be suppressed) OUTSIDE TEMP 199°C OUTSIDE TEMP 199°F

FUEL GAUGE

There are 3 types of Fuel Computer information is available to you as indicated in table below, which you can select by using " Display Information Control (DIC) " & "Trip" switches (Refer Switch functions).

1. Instantaneous fuel consumption
2. Average fuel consumption
3. Range

Sr. No.	Function	Text on Display Screen	Unit		
			Option 1	Option 2	Default Setting
1	Instantaneous Fuel Consump.	INST FUEL	Km/l	L/100km	Km/l
2	Average Fuel Consumption "A"	AVG FUEL	Km/l	L/100km	Km/l
3	Average Fuel Consumption "B"	AVG FUEL	Km/l	L/100km	Km/l
4	Range (Distance to Empty)	RANGE	Km	-	Km

1) Instantaneous Fuel Consumption:

Updates display “Instantaneous Fuel consumption” at regular time interval.

Instantaneous Fuel Consumption display is available in “Km/l” or “L / 100km” which can be selected by user by using “Display Information Control (DIC) & Trip” switches (Ref. Switch functions).

Instrument Cluster displays “Instantaneous Fuel Consumption data” only when the below conditions are met :

- Cluster display “ - . -” when ignition ‘ON’ and engine ‘OFF’.
- Your vehicle’s speed is more than 10 Km/h.
- Your car should have covered 20 meters after switching ON the ignition.
- Cluster displays “ - . -” till the above conditions are met.

2) Average Fuel Consumption:

This function updates the display “Average Fuel consumption” since it was last reset.

Average Fuel Consumption display is available in “Km/l” or “L/100km” which you can select by using “Display Information Control (DIC) & Trip” switches (Ref. Switch functions).

Distance covered is more than 500 meters. It refresh the value every 10 seconds.

3) Range (Distance to Empty) (DTE):

Range option indicates distance that your car can travel with available fuel in tank under current Average Fuel consumption rate and it displays as “km”.

Cluster starts updating Range data only when the below conditions are met :

- Engine speed is more than 0 RPM
- Vehicle speed is more than 0 Km/h
- Cluster displays the same / current DTE values unless and until the car starts moving.

Outside Ambient Temperature:

Outside Ambient Temperature is measured and displayed in the units °C or °F, which you can select by pressing the “Display Information Control (DIC) & Trip” switches (Ref. Switch functions).

If your car’s speed is less than 30 Km/h, the displayed “Outside Ambient Temperature” value may not be accurate.

Switch Functions: When “Display Information Control (DIC)” Switch in “Trip” Mode:

Display selection by “Trip” switch			
Sr. No.	Indication on Display	If “Trip” switch is pressed & released immediately	If “Trip” switch is pressed & released after a delay
1	Main Odometer and Trip meter “A”	Display changes to Trip meter “B” with Main Odometer.	Resets Trip meter “A” value and Average Fuel Consumption “A” value.
2	Main Odometer and Trip meter “B”	Display changes to Trip meter “A” with Main Odometer.	Resets Trip meter “B” value.

Switch Functions: When “Display Information Control (DIC)” Switch in “Fuel” Mode:

Display selection by “Trip” switch :			
Sr. No.	Indication on Display	If “Trip” switch is pressed & released immediately	If “Trip” switch is pressed & released after a delay
1	Range (Distance to Empty)	Display changes to Average Fuel Consumption “A”	-
2	Average Fuel Consumption “A”	Display changes to Average Fuel Consumption “B”	-
3	Average Fuel Consumption “B”	Display changes to Instantaneous Fuel Consumption	-
4	Instantaneous Fuel Consumption	Display changes to Average Trip Speed	-
5	Out side Ambient Temperature	Display changes to Range	-

Switch Functions: When “Display Information Control (DIC)” Switch in “Set” Mode

Display selection by “Trip” switch :

Sr. No.	Indication on Display	If “Trip” switch is pressed & released immediately	If “Trip” switch is pressed & released after a delay
1	Select Units	Display does not change.	Cluster enters into “Distance unit selection” mode. (Refer below section)
2	Language Selection (only for export market)	Display changes to “Unit Selection” mode.	Cluster enters into “Language selection” mode. (Refer below section)

Switch Functions: Distance Unit Selection

Display selection by “Trip” switch:

Sr. No.	Indication on Display	If “Trip” switch is pressed & released after a delay	If “Trip” switch is pressed & released immediately
1	Distance Units	Displays distance unit as “miles” with arrow mark.	Display changes to “Fuel unit selection” mode.
2	Distance unit with “miles”	Displays “Setting Saved” for 3 secs. (i.e. Distance unit selected is “miles”) and display changes to “Fuel unit selection” mode.	Displays distance unit as “km” with arrow mark.
3	Distance unit with “km”	Displays “Setting Saved” for 3 secs. (i.e. Distance unit selected is “km”) and display changes to “Fuel unit selection” mode.	Displays distance unit as “miles” with arrow mark.

Switch Functions: Fuel Unit Selection

Display selection by "Trip" switch:			
Sr. No.	Indication on Display	If "Trip" switch is pressed & released after a delay	If "Trip" switch is pressed & released immediately
1	Fuel Units	Displays Fuel unit as "L/100km" with arrow mark.	Display changes to "Temperature unit selection" mode.
2	Fuel unit with "L/100km"	Displays "Setting Saved" for 3 secs. (i.e. Fuel unit selected is "L/100km") and display changes to "Temperature unit selection" mode.	Displays Fuel unit as "MPG" with arrow mark.
3	Fuel unit with "km/l"	Displays "Setting Saved" for 3 secs. (i.e. Fuel unit selected is "km/l") and display changes to "Temperature unit selection" mode.	Displays Fuel unit as "L/100km" with arrow mark.

Switch Functions: Temperature Unit Selection

Sr. No.	Indication on Display	If "Trip" switch is pressed & released after a delay	If "Trip" switch is pressed & released immediately
1	Temperature Units	Displays Temperature unit as "°C" with arrow mark.	Display changes to "Unit selection" mode.
2	Temperature unit with "°C"	Displays "Setting Saved" for 3 secs. (i.e. Temperature unit selected is "°C") and display changes to "Unit selection" mode.	Displays Temperature unit as "°F" with arrow mark.
3	Temperature unit with "°F"	Displays "Setting Saved" for 3 secs. (i.e. Temperature unit selected is "°F") and display changes to "Unit selection" mode.	Displays Temperature unit as "°C" with arrow mark.

Facia switches :



1. Reverse Parking System (RPS)
2. 4 X 2 Switch (with LED)
3. Hazard Warning Switch
4. ESP OFF Switch
5. LOCK Switch
6. UNLOCK Switch

1. Reverse Parking Buzzer ON/OFF Switch

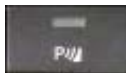

Your reverse parking assistance system gets activated when you engage reverse gear and simultaneously a beep sound starts. The intensity of the beep keeps on increasing as your vehicle comes closer to the obstacle. Press switch (1) to mute the beep.

2. 4 X 2 Switch (with LED)



Same previous selected mode (4X4 or 4X2) during last switched 'OFF' position will be retained when you restart.

In the 4x4 mode, power from the engine is supplied to all the four wheels. If you do not want your car to run in the 4x4 mode, press the 4x2 switch on the Facia. LED on Fascia switch glows to indicate that the 4x4 mode is disabled. By doing so, the TOD (Torque On Demand) function is also disabled.

3. Hazard Warning Switch



When hazard warning switch is pressed, the right and left direction indicators along with tell tales on the instrument cluster and hazard warning LED start flashing simultaneously. To switch Off the function, press the Hazard warning switch again.

When pressed, the Hazard function overrides the turn indicator (right, left) function.

NOTICE

During hazard ON condition, if power is switched OFF, the function is switched OFF but is activated once the power is turned ON.

4. 'ESP OFF' Switch



'ESP OFF' switch is provided on the facia. To disable the ESP, press the 'ESP OFF' switch. TCS system will also get disabled along with the ESP once the 'ESP OFF' switch is pressed.

NOTE

After switching OFF the ESP, the tell tale (ESP Indicator) on the instrument cluster will come ON and it goes OFF when ESP is activated.

5. LOCK / UNLOCK Switch :



These switches are provided to lock/unlock the doors. By pressing the LOCK/ UNLOCK button all the doors can be locked / unlocked.

STEERING WHEEL SWITCHES :

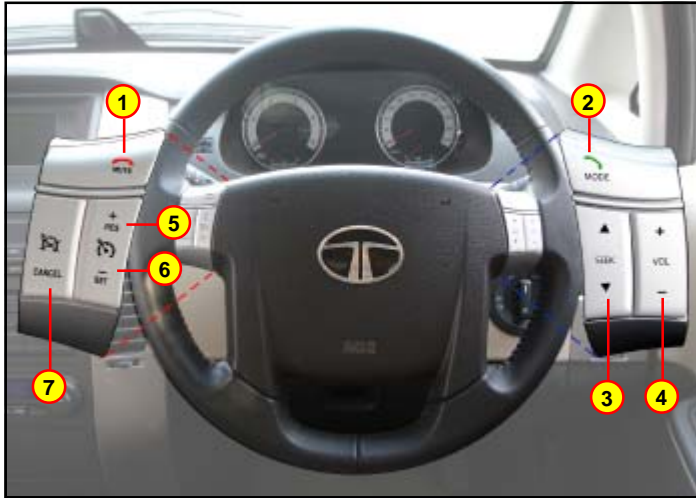

- | | | |
|-----------|----------|---------|
| 1. MUTE | 2. MODE | 3. SEEK |
| 4. VOLUME | 5. RESET | 6. SET |
| 7. CANCEL | | |

FUNCTIONS :

You can control various functions by using the switches on the steering wheel.

Detailed Information on various functions of these switches are available in 'INFOTAINMENT MANUAL'.

5, 6 & 7. Cruise Control functions

Reset and Set Switch :

Increment / Decrement : Using this function, you can either increase or decrease vehicle speed. Press (+) for increasing the vehicle speed and press (-) for decreasing the vehicle speed.

Cancel Switch : Press this switch to cancel the Cruise Control function.

(Please refer to Cruise Control section for details)

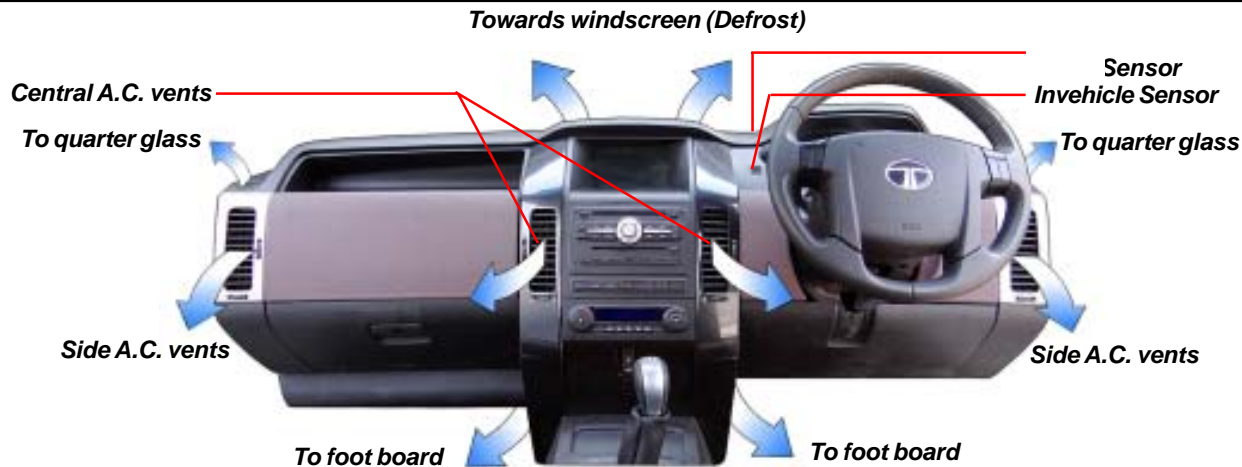

PERSONALISED VENTS FOR EACH PASSENGER



A.C. air vents on 'B' pillar for second row seat



A.C. air vents on floor console for Second row middle seat



A.C. air vents on 'C' pillar for third row seat

Heating, Ventilation and Air conditioning :

Aria is available in two types of HVAC systems :

- 1) **Manual HVAC**
- 2) **FATC (Fully Automatic Temp. Control)**

1) MANUAL HVAC:

HVAC controls temperature, humidity and air flow to enhance comfort level inside the car. It also helps to keep windscreen and window glasses clear for better visibility.

The engine must be running for the heater and air conditioning to generate hot and cold air.

The system is equipped with a Heating, Ventilation and Air conditioner along with adjustable vents on dashboard and console. The system has a separate rear cooling system along with adjustable vents on B and C pillar.

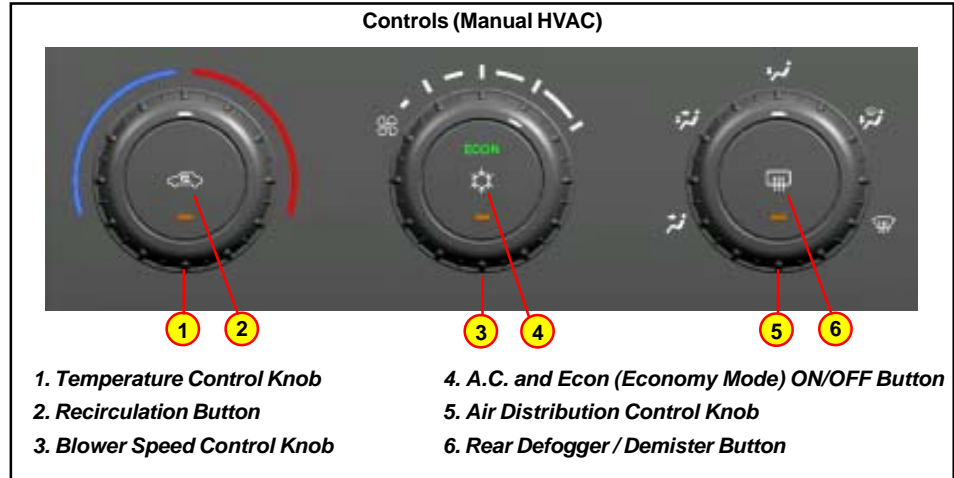

The system is also equipped with a front heating systems for clearing the front windscreen, side glasses of fog or frost and to heat the cabin in cold weather.

Vent Controls :

The direction of air flow from the vents can be adjusted manually by revolving thumb wheels / knobs.

Temperature Control Knob and Recirculation Button:



A. Temperature Control Knob

The temperature of the cabin can be controlled by operating the temperature control knob. The temperature can be increased by rotating the knob towards the red segment (clockwise) and decreased by rotating it towards the blue segment (anti-clockwise).

B. Recirculation Button:

When the recirculation indicator is 'ON', the air within the cabin is recirculated. When the indicator is 'OFF', air is being used in from outside of the vehicle (Fresh air mode).

Continuous operation in Recirculation mode depletes the oxygen inside cabin and user may feel dizzy. Whenever discomfort is felt switch to fresh air circulation mode.

The outside air intakes for the heating and cooling system are at the base of the windscreen. Keep this area clear of leaves and other debris.

The system should be used with recirculation air mode for faster heat up and cool down, however keeping the system in recirculation mode, particularly with A/C 'OFF', can cause the windows fog up.

Always switch to recirculation mode when driving through dusty or smoky conditions.

Blower Speed Control Knob and A.C. ECON mode ON-OFF Button :

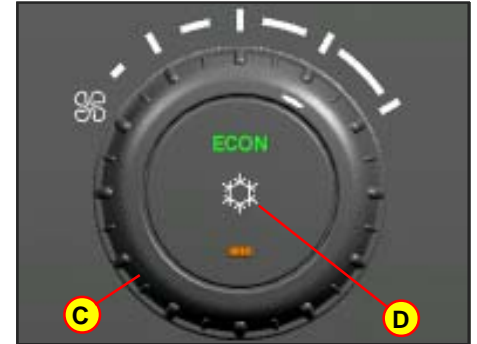

C. Blower Speed Control Knob :

The HVAC system has a four speed blower. The blower speeds can be regulated by operating the blower knob (C) at the centre of the control panel.

D. A.C. & ECON mode ON-OFF Button :

First Press : Normal A.C. is switched 'ON'.

Second Press : ECON mode turns 'ON' with A.C..

Third Press : Both A.C. and ECON functions are switched 'OFF'.

Econ A.C. :

During ECON A.C. operation the system automatically cuts off at a higher temperature than normal A.C. The operation can be used during mild weather conditions for better fuel efficiency. Comfort level may be compromised during this operation.

Air Distribution Control Knob / Demister Button :

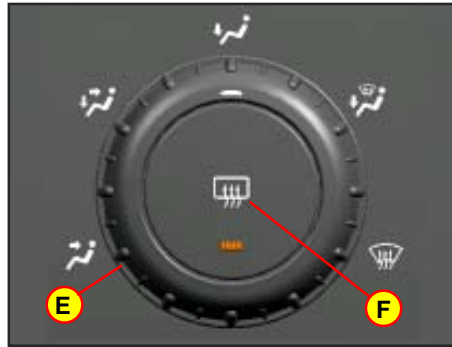

E. Air Distribution Control Knob :

The air flow can be changed by turning the air direction control knob (E) to the desired direction.

 Towards face

 Towards face and feet

 Towards feet



Towards feet and windshield
(Recommended for clearing mist on windshield)



Air demist/defrost windshield
(Recommended for clearing heavy fog or snow)

F. Rear Demister / Defogger Button:

Press the button (F) to turn ON the rear windshield and outside rear view mirror demister. This clears the fog / mist formation on the rear windshield and outside rear view mirror.

The indicator on the button turns ON when the rear demister is ON. The demister turns OFF automatically after 15 minutes.

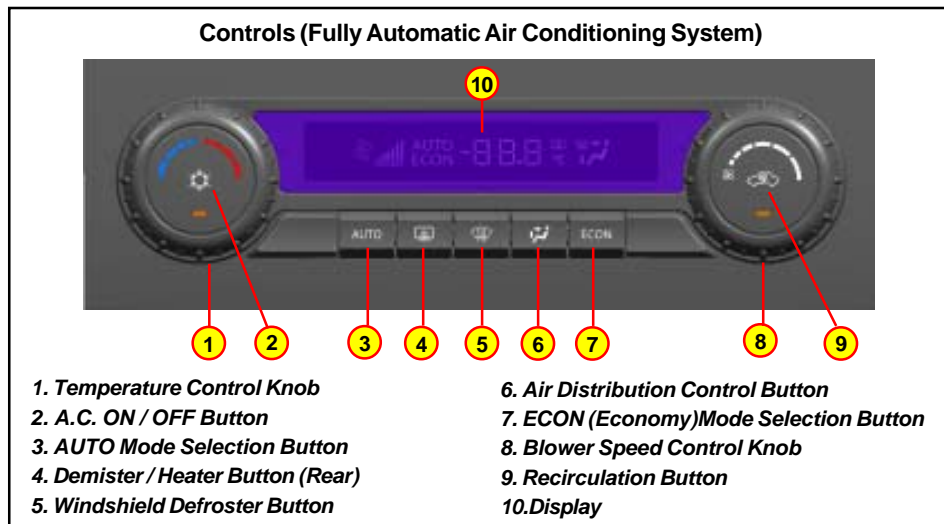
2) FULLY AUTOMATIC TEMPERATURE CONTROL (FATC):**General Description :**

FATC system controls the in-cabin temperature of the vehicle automatically and provides maximum passenger comfort regardless of the outside weather conditions.

⚠ CAUTION

If the display flashes 'ERR' in periodic pattern of 30 sec. 'ERR' and 5 sec. set temperature. It indicates FATC malfunctioning. Switch over to manual mode and contact TATA authorised service station.

Automatic Operation :

To put the automatic climate control in fully-automatic mode:

1. Press the 'AUTO' button.
2. Set the desired temperature by turning temperature control knob.
The display will show all the function during 'AUTO' mode.

The System automatically selects the proper mix of conditioned and / or heated air that will, as quickly as possible, raise or lower the interior temperature to your preference.

When you set the temperature to its lower limit (Lo) or its upper limit (Hi), the system runs at full cooling or heating only (AC ON). It doesn't regulate the interior temperature.

To come out of 'AUTO' mode, press 'AUTO' button again.

To turn everything OFF :

Turning the blower speed control knob in extreme anticlockwise position will switch 'OFF' the system.

- Keep the system 'OFF' for short periods only.
- To avoid stale air and collection of mustiness from collecting, you should have the fan running at all the times.

Semi-automatic Operation :

You can manually select various functions of the climate control system when it is in fully automatic mode. All other features remain automatically controlled. Making any manual selection causes the word 'AUTO' in the display to go out and overridden setting is displayed. System will remain in semi-automatic mode till 'AUTO' is re-pressed.

A.C. ON/OFF Button :

Press the A.C. ON/OFF button to turn the air conditioning on and off. You will see LED on / off on knob.

Temperature Control Knob :

Turning the temperature control dial clockwise the desired temperature will increased by steps of 0.5° C (1° F). User can select temperature range from

16° C to 30° C increases the temperature of the air. Where as the anti-clockwise direction decreases the the temperature.

Recirculation Button :

When the recirculation button is switched 'ON', air from the vehicle's interior sent through out the system. When the recirculation button is switched 'OFF', air is brought in from the outside of the vehicle (fresh mode)

Whenever discomfort is felt switch to fresh air circulation mode.

The out side air intakes for the climate control system are at the base of windscreen. Keep this area clear from leaves and other debris.

The system should be used with recirculation air mode for faster heat up and cool down, however keeping the system in recirculation mode, particularly with A/C 'OFF', can cause the windows fog up.

Switch the recirculation mode when driving through dusty or smoky condition, then turn to fresh air mode.

Blower Speed Control Knob :

Rotate the blower speed control Knob to adjust the desired blower speed.

Rotate the knob clockwise to increase the blower speed up to the MAX, where as the anti-clockwise would reduce the speed up to 'OFF'.

In 'AUTO' mode, the FATC system will regulate the blower speed automatically.

Air Distribution Control Button :

In AUTO mode, the FATC system will regulate the blower speed automatically. However user override is possible with the use of air distribution control button to select the desired airflow mode.

Each time you press the air distribution control button. the display show the mode selected.

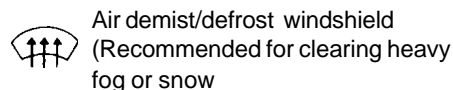
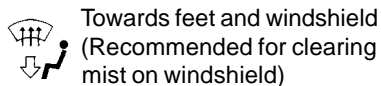
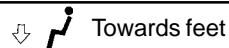
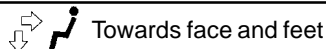
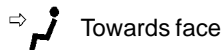
**Windscreen Defroster Button :**

This button directs the main airflow towards windscreen for faster defrosting.

It also overrides any mode selection you may have made.

When you select windscreen defroster button the system automatically switches to fresh air mode and turn on the A.C.

When you turn 'OFF' the button again the system returns to its former settings.

For your safety make sure you have a clear view through all the windows before driving.

Rear Window Demister Button :

This button turns the rear window demister 'OFF' and 'ON'. The system deactivates after 15 min of continuous operation.

ECON A.C. :

During ECON A.C. operation, the system automatically cuts off compressor at a higher temperature than normal A.C. The operation can be used during mild weather conditions for better fuel efficiency. Comfort level may be compromised during this operation.

Rear A.C. Operating instruction :

Rear A.C. blower control switch is provided on the roof near interior lamp. Desired speed can be selected for second and third row occupants. The cool air will come when front A.C. is ON. Keep air vents fully closed, when and where not required.

NOTE

HVAC system is fitted with 3 sensors. A solar sensor on top of the dashboard on the right side of defrosts grill and an in-vehicle sensor on the cover of the instrument cluster. Third one is Outside Ambient Temperature (OAT) sensor located under the front grill.

CAUTION

1. Do not cover or spill any liquid on sensors.
2. Do not cover sensor, this may cause the sensor to malfunction. This may lead to FATC not functioning to desired level.

TFT / LCD Display :

(Thin Film Transistor) screen. However If your vehicle is fitted with a reverse guiding sensors, it displays a graphical image on a LCD (Liquid Crystal Display) screen.

For detailed information, please refer 'MUSIC SYSTEM / INFOTAINMENT' manual, which is supplied along with the Owner's Manual.

The TFT / LCD screen is provided in the central console of your vehicle. It turns 'ON' when the 'IGN' is switched 'ON' and it displays DATE & TIME.

When you switch 'ON' infotainment system, it displays AUDIO information (AM / FM / CD / USB / AUX / Phone etc.)

When you engage the reverse gear and your vehicle is fitted with a reverse guiding camera, it displays a wide and actual view behind your vehicle on a TFT

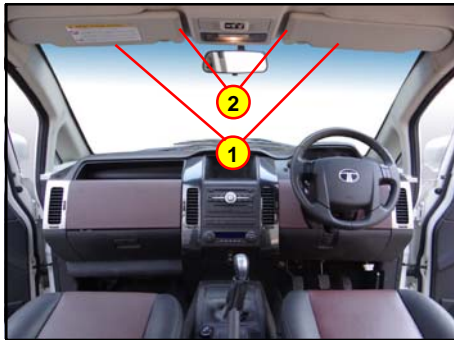
Sun visors (Driver and Co-driver):

1. Sunvisors 2. Extensions

Two adjustable sun visors with extensions are provided inside the cab above the windshield to prevent sun glare. Lower the sun visors to protect the eyes from bright sunlight. The sun visors can also be moved sideways towards the door.

NOTE

When not in use, keep the sunvisors in their original position or else, they may block driver's vision. Push in the extensions before folding the sunvisors.

Vanity Mirror on passenger side sunvisor (if applicable):

Vanity Mirror (Cover closed)



Vanity Mirror (Cover opened & Lights ON)

The vanity mirror is provided in the co-driver side sunvisor. It has a cover flap for protection. The lights are also provided on the both sides of the mirror. The lights turn 'ON', when vanity mirror cover is opened and remain ON as long as the vanity mirror cover is open.

NOTE

When not in use, keep the vanity mirror cover in closed condition.

Grab Handles & Coat Hook :

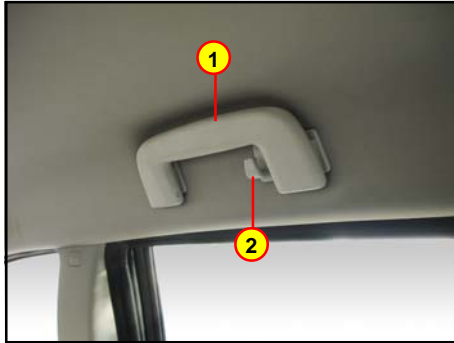

1. Grab handle 2. Coat Hook

Grab handles are provided on all seats except driver seat. This helps in comfortable positioning of passengers during a journey.

A coat hook is also provided along with the grab handle.

NOTE

Avoid hanging of heavy goods on to the coat hook.

Goggle Case :



A goggle case is provided above the driver's door.

Cup holders for third row passengers :



Cup holders are provided for both the third row passengers. Lift the cover to access the cupholder .

Cup Holders for second row seat middle passengers :

A single cup holder is provided on the centre console for second row middle passenger. To access, push open the lid above the rear A.C. vents.

Push down the lid when not in use.

Utility pockets on door trims:

Utility pocket is provided on all the four door trims, which gives you extra space to keep magazines/ papers / drinking water bottle etc.

Power Sockets:

Three power sockets are provided at the following locations along with illumination ring :

1. On centre console behind parking brake lever for front passengers :



Push the cover gently and pull out the socket cover to open and access the power socket.

2. On centre console below A.C. vents for middle passengers :



Push the cover gently and pull out the socket cover to open and access the power socket.

3. Behind left hand side third row seat for rear passengers :



Pull out the socket cover to open and access the power socket.

The all three sockets can be used to tap 12V supply (10A Max.) for operating external gadgets such as cigarette lighter, Car fridge, Vacuum cleaner etc.

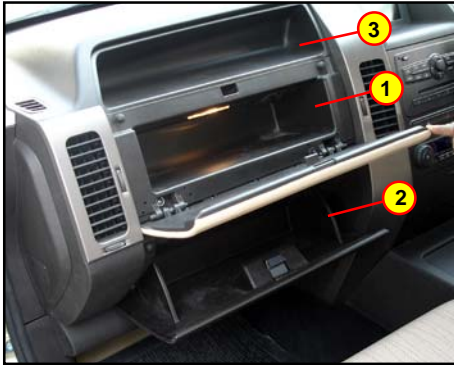
Glove box & Top Stowage Box :

1. *Glove Box with cooling facility*
2. *Glove Box*
3. *Top Stowage Box*

Glove Box with a cooling facility :

Glove Box with a cooling facility is provided on the dashborad, which helps you to keep the store cool from inside. It cools the glove box only when the front A/C is ON. Shut OFF the vent by rotating the knob, whenever cooling is not required.

A Lamp is provided in the glove box for illumination. This lamp will remain ON till the glove box cover is open, which is spring loaded.

Glove Box :

A regular glove box is also provided on the dash board below glove box with cooling facility. It can be locked with the ignition key.

Top Stowage Box :

A top stowage box is provided above the glove box, where you can keep small and loose items.

INTERIOR LIGHTS :

Ambient Interior Roof Lamps:

The Ambient Interior roof lamps are mounted in the roof console at the following three different locations :

1. Near Inner rear view mirror (First row seat)
2. Above second row seat
3. Above third row seat



Near Inner rear view mirror

The middle switch has three positions - **ON**, **OFF** and **DOOR**.

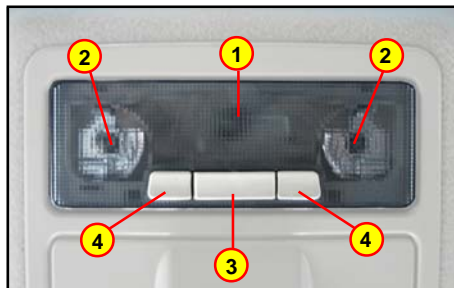

1. Room Lamp 2. Spot / Reading lamp
3. Room Lamp Switch 4. Spot Lamp Switch

ON : In this position, the lamp remains continuously ON irrespective of whether the doors are opened or closed.

OFF : In this position, the lamp remains continuously OFF irrespective of whether the doors are opened or closed.

DOOR : In this position, the lamp comes ON when any of the doors are opened and dims out when the door/s are closed.

Spot Lamp / Reading Lamp :

The lamp has two separate switches to operate the spot / reading lamps on either side.

These lamps are not provided in the roof lamp above third row seat.

Music System :(If provided)

A music system is provided in your vehicle in the central console.

Tweeters are provided on front 'A' pillar and on rear doors below rear door lock knob. Speakers are provided on dashboard and on all the doors including tailgate. Amplifier for music system is located on rear left below the rear power socket.

A separate operator's manual of the music system is provided along with the Owner's Manual of this vehicle.

! CAUTION

Insert only one CD at a time in the CD slot.



Tweeter located on 'A' pillar



Speaker located on door trim

Antenna :

Antenna located on third quarter glass

Printed antenna is located on the left hand side third quarter glass.

! CAUTION

Do not rub the glass with a dry cloth from inside, this may damage printed circuit of the antenna.

Removal of Music System :



Pins for removal of music system

Music system can be removed from your vehicle using special pins, which are available in market.

Press both the pins simultaneously, remove the connectors and take out the music system.

USB / AUX ports :

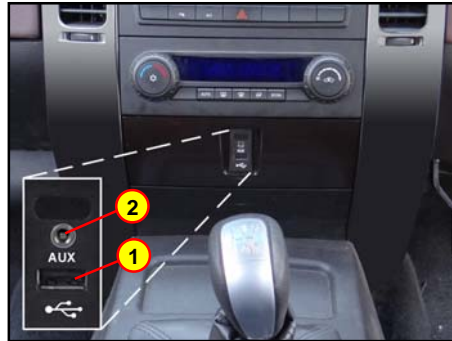

1. USB port 2. AUX port

USB and AUX Ports are provided just below HVAC control panel on the front console.

Functions :

USB port :

You can attach external memory devices like memory sticks / Pen Drives, I-Pods for playing music tracks stored in these devices through the car's music system.

AUX port :

The AUX port can be used to attach devices like ear / head phones, extra speakers, etc.

Head lamps :

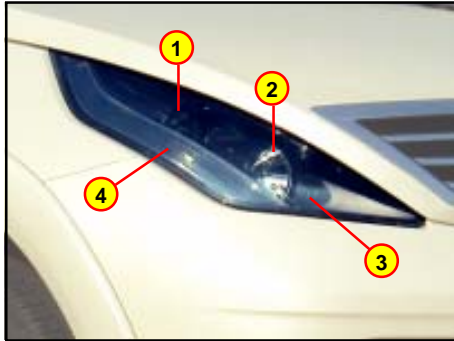

- 1. Low beam
- 2. High beam
- 3. Parking
- 4. Side indicator

Head lamps are clear lens type having multi focal reflector and are provided with halogen bulb for providing straight ahead illumination of the road for the long distance or dip beam which illuminates the road immediately ahead for short distance visibility. It also contains side indicator lamp and a parking lamp.

Fog lamps :



Front and rear fog lamps are provided for your convenience and they can be operated via master light switch located on the dash board near steering column (RH side).

These are provided for additional illumination and to be used during rainy or foggy conditions.

Tail lamps :

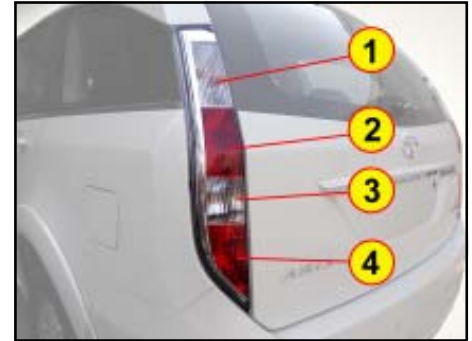

- 1. Turn Indicator
- 2. Stop & rear position lamp
- 3. Reverse Lamp
- 4. Fog Lamp



Registration number Plate lamps :

- 1.Registration / Number Plate Lamps
2. High Mounted Stop Lamp

Two concealed lamps are provided for illumination of the rear registration / number plate, which turns ON along with the headlamp.

High mounted stop lamp :

High mounted stop lamp is provided on the tail gate, and it glows whenever the brakes are applied.

Puddle / Door lamps :

Puddle / door lamp is provided on the entire four door trim bottom. It has two parts, one is white at bottom and other is red on the side. It illuminates as you open the door. The white light at the bottom helps you to visualize the ground clearly. This assist the user for easy entry and exit during night. Similarly the red light on the side helps others to recognize that your door is open. It warns the traffic coming from the rear that door is open.

Cargo Lamp :

The cargo lamp is provided in the luggage space behind third row seat near plug socket.

Reflex reflectors :

Two reflex reflectors are provided at the both corners of the rear bumper. They glow by light of the vehicle coming from behind, which helps to recognize your vehicle on the road.

Fuel flap opening / closing :**Opening :**

- **“UNLOCK”** your vehicle, using the central locking system (by switching “OFF” the ignition or unlocking the driver’s door or using the Remote).
- Now by gently pushing, open the fuel flap (fitted at left hand side of the vehicle).

Closing :

- Gently push to lock the fuel flap back to it’s position.
- It gets locked once the vehicle is locked using the central locking.

Manual Fuel flap opening :

You can open your vehicle’s fuel flap manually, if there is a problem in the central locking system. For this just follow the below steps;

- Open the Tail Gate
- Open the Trim Cover fitted to the left hand side behind third row seat.
- Once this cover is opened, you will find a cable with a knob near the jack.
- Slightly pull this knob to open the fuel flap.

NOTE

The emergency fuel flap opening cable should be used only in case of emergency / failure of central locking system / electrical system, to open the fuel flap.

Opening and closing the bonnet:**Opening:**

1. Ensure that the vehicle is in neutral gear with the parking brake applied.
2. Pull the bonnet release lever located under the right hand corner of the dash board. The bonnet will pop up slightly.
3. Raise the bonnet slightly and with your finger lift the secondary lock lever located under the bonnet centre.
4. Lift the bonnet up. Balancers hold the bonnet.

Closing:

1. To close the bonnet, hold the bonnet and pull down it slowly.
2. Drop it from a short height to shut. It will lock automatically. Ensure that the bonnet is locked properly.

⚠ CAUTION

Ensure that the bonnet is properly locked before driving. Do not press the bonnet onto the bonnet lock.



Location of Bonnet release lever



Bonnet release lock

THEFT DETERRENT SYSTEM:**Immobilizer system:**

Immobilizer system is designed to prevent car theft by electronically disabling the engine starting system. The engine can be started only with car's original Immobilizer ignition key which has an electronic identification programmed code.

Immobilizer system consists of following components,

- 1) Immobilizer unit (ICU) – Add-on part on the ignition switch fitted on steering column.
- 2) Two Electronic keys (E-key) - To start the car.

⚠ CAUTION

- 1) E-key of other cars will not start the engine.
- 2) *Customer should,*
 - a. *Use only one E-key .*
 - b. *The other E-key should be kept at safe location.*

c. Note down “key Tag no.” information (and keep it safe) which is required while getting new / spare keys. Please note that It is not possible to prepare new/spare keys without “key Tag no.”

d. Take precaution about E-keys, as without it car cannot be started.

E-Keys :**Unlocking Principle :**

The E-keys are learned for a specific immobilizer and are unique to the car. The transponder inbuilt into the ignition E-key carries a unique identification code. The Engine management system (EMS) and Immobilizer has common secret code. Both these codes are used while unlocking the car.

When key is inserted and the ignition is switched “ON”, all the codes are communicated within concerned

components (E-key, Immobilizer and EMS). The engine starts only if all codes match. In case of a mismatch of the codes, system prevents the engine from starting.

Loss of E- Keys :

If any one of the E-key is lost, **contact TATA dealer as soon as possible** to have the lost key deactivated and to have the new E-key. Please note that Second original E-key is required for making additional E-keys.

If both the E-keys are lost, contact the authorized TATA dealer

NOTE**Do's and Don'ts of immobilizer system**

1. Do not turn ON ignition switch by using electronic key with any type of metal wound around its grip or in contact with it. This may be detected as abnormal condition by immobilizer and prevent engine from starting.

2. Do not leave electronic key in areas of high temperature. The transponder in E-Key will behave abnormally when reused.
3. Do not try to start the car when the Immobiliser indicator lamp on the instrument cluster is glowing. In this condition the car will not start and the car's battery will also be drained due to frequent cranking.

Immobilizer system Brief :

The behavior of Immobilizer and car under "Ignition OFF and ON" conditions, is explained in table below with immobilizer status lamp ("lock" symbol on the instrument cluster)

CAR CONDITION	STATUS LAMP	CAR STATE	MEANING/ FUNCTION OF THE STATE
Ignition OFF	Blinking	Locked	Car Immobilized and Awaiting Electronic key
Ignition ON	OFF	Unlocked	Normal Condition Ready to start the car
	ON	Locked	<ul style="list-style-type: none"> - Problem with key (Wrong Ekey used to start car) - Problem with Immobilizer system contact Tata dealer to inspect the system

Airbag (SRS) : (If fitted)

The vehicle has front airbags for both the driver and front passenger as a supplement to the seat belt restraint systems. The driver's airbag is mounted in the center of the steering wheel. The front passenger's airbag is located in front of front passenger seat inside the dashboard, above the glove box.

The vehicle fitted with the airbags has suitable indications on steering wheel and on dash board. The word 'SRS' is embossed on the airbag covers.

The side & curtain airbags are provided to protect the heads of the front seat & rear out board seat occupants in certain side collision.

Provided that the occupants are correctly seated with seat belts properly worn, front airbags will provide additional protection to the chest and facial area of the front seat occupants in the event of severe frontal collision.

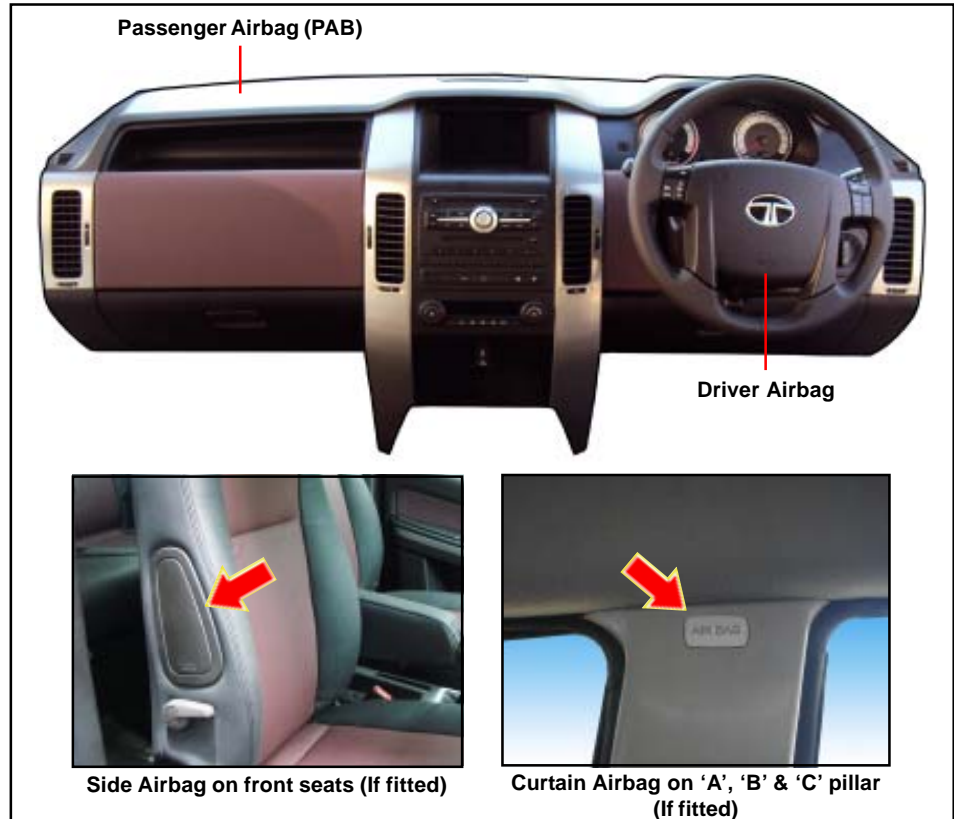

WARNING

- The airbag is a supplementary restraint system that provides ADDITIONAL protection in a severe collision only. It does NOT replace the need to wear a seat belt. Relying on the airbags alone could lead to severe injuries in a collision. The airbags work with your seat belt to restrain you properly. Always wear your seat belts even though you have airbags.
- To ensure correct deployment of the airbags, it is essential that obstructions are not allowed to intervene between airbag and the occupant. Do not put anything on or around the front airbag covers or attempt to open them. You may damage the airbags and you could be injured because the airbags are no longer functional. These protective covers for the airbag cushions are designed to open only when the airbags are inflating.

- Seating position plays an important role in minimizing the risk of accidental injury. In addition to properly worn seat belts, both driver and front passenger should adjust their seat to provide the maximum practical distance from the front airbags. Airbags need room to inflate. Being too close to the steering wheel or dashboard during airbag deployment could cause serious injury.

Passenger airbag (PAB) switch:

If it becomes necessary to fit a child restraint on the front passenger seat, the airbag must be de-activated using the switch located on the left side of the dashboard. This switch can be accessed once codriver side door is opened.

On the contrary, when an adult is seated in the front passenger seat, ensure that PAB disabling switch is turned to 'ON' position. This will ensure that the passenger airbag is operational in the event of a collision.

This switch is operated using the ignition / remote key.

PAB operational status indicator:

'PAB' operational status indicator is located on roof panel near the inner rear view mirror. When the PAB disabling switch is turned to 'OFF' position to deactivate the passenger airbag, a yellow LED comes 'ON' and when turned to 'ON' position, an orange LED comes 'ON'.

WARNING

When PAB disabling switch is turned 'OFF', make sure 'PAB' operational status lamp illuminates with ignition 'ON', indicating that the passenger airbag is NOT operational. If the airbag SRS warning indicator in the instrument cluster illuminates continuously, it means that there is malfunction in the system. Remove the child restraint from front passenger seat and contact your TATA authorised dealer.

When PAB disabling switch is turned 'ON', the 'PAB' operational status lamp turns 'ON' with ignition 'ON' indicating that the passenger airbag is operational. If the airbag 'SRS' warning indicator in the instrument cluster illuminates continuously, it means that there is malfunction in the system. In such case please contact TATA authorised dealer.

Airbag warning label:

Airbag warning information is printed on the co-driver's sun visors.

Airbag SRS warning indicator:

The air bag warning symbol comes on for approximately 3 seconds when the ignition is turned 'ON' and goes 'OFF'.

WARNING

If it remain 'ON' or blinks, take your vehicle to the nearest Tata Authorised Service Centre.

Airbag SRS system components:

The airbag 'SRS' system consists of the following:

- Airbag 'SRS' ECU (Electronic Control Unit)
- 'SRS' Indicator
- Driver Airbag
- Front Passenger Airbag
- Front Impact Sensors
- Driver and Front Passenger Seat Belt Pretensioners with load limiters
- Supplemental Front Seat-Mounted Side Airbags
- Side Remote Acceleration Sensors
- Electrical Wiring Harness

Airbag 'SRS' working:

In the event of a collision, airbag SRS ECU monitors the rate of deceleration induced by the collision, through impact sensors, to determine whether the airbags should be deployed.

NOTE

The airbag 'SRS' is not designed to operate as a result of roll - over, rear collisions, minor frontal or side impacts nor will it operate as a result of heavy braking or driving over bumps and pot holes.

Airbag inflation is virtually instantaneous and occurs with considerable force, accompanied by loud noise. The inflated airbag, together with seat belts restraint system, limit the movement of an occupant, thereby reducing the risk of injury.

When an airbag inflates, you may see some smoke-like particles. The particles are a normal by-product of the process that generates the nontoxic gas used for airbag inflation. These airborne particles may irritate the skin, eyes, nose, or throat. If you have skin or eye irritation, rinse the area with cool water. For nose or throat irritation, move to fresh air. If the irritation continues, see

your doctor. Also sometimes the smoke can cause breathing problems for people with a history of asthma or other breathing trouble. In such cases get fresh air promptly.

After inflation airbags deflate immediately thus providing a gradual cushioning effect for the occupant. It is not advisable to drive your vehicle after the airbags have been deployed. If you are involved in another collision, the airbags will not be in place to protect you.

WARNING

After inflation, some airbag components are hot. DO NOT touch them.

WARNING

Airbag SRS fitted in your car does not require any regular maintenance, however ALWAYS contact your TATA authorised dealer if:

- The warning indicator fails to illuminate for 3sec when ignition switch is turned ON.
- The warning indicator remains ON beyond 3 seconds after ignition switch is turned ON.
- The warning indicator illuminates after the engine is started or while the vehicle is running.
- An airbag inflates
- The front or side of the vehicle is damaged, even if airbag has not inflated.
- Any part of airbag module cover shows sign of cracking or damage.

WARNING

- Do not fit any bull bars or other after market accessories at front side of the vehicle. This may affect the proper deployment of the airbag.
- Never place any loose object on the dash board in front of co-driver seat. It may result an injury from the object when it is forced towards you by the inflating airbag.
- Do not cover the steering wheel or dashboard with an object, which may prevent the proper deployment of the airbag.
- Never try to repair any component or part of the SRS yourself. Any interference in the system could cause malfunction and serious injury. All work on SRS should be performed by TATA authorised dealer.
- The use of seat covers on the front seat may affect side air bag deployment.

- Never hang heavy items to the grab handles. This could affect deployment of the side curtain air bags.

Anti-Lock Braking System (ABS) (if equipped):

In addition to the conventional hydraulic brake system, an Anti-lock Braking System (ABS) incorporating Electronic Brake Distribution (EBD) is provided on Tata Aria (ABS version).

During normal braking the Electronic Brake Distribution (EBD) limits the level of braking force transmitted to the rear wheels. 'EBD' moderates the braking forces at the rear axle depending upon the load condition and available traction at the rear wheels.

During emergency braking the Anti-lock Braking System (ABS) regulates the braking force for each individual wheel. In doing so the system optimizes the level of braking being achieved while maintaining a stable, controllable vehicle. Where 'EBD' only acts on the rear wheels the ABS is able to control each wheel individually. Both the 'EBD' and the 'ABS' functions work by continuously monitoring and comparing

the four individual wheel speeds and reacts when a wheel is detected as losing traction with the road surface, which happens when a wheel tends to lock during braking.

To avoid the wheels from locking and prevent the vehicle from skidding ABS is provided. It prevents the wheels from locking and maintains the steerability of the vehicle thereby helping the driver to maintain stability of the vehicle while bringing it to a stop in the safest possible way.

NOTE

During Cranking ABS, EBD warning lamps might glow for a few seconds.

In order to obtain the maximum benefit from your 'ABS' system in an emergency situation, do not attempt to modulate the brake pressure by pumping the brake pedal. Press brake pedal continuously as hard as possible or as the situation demands. When ABS intervention is necessary

the warning lamp will not illuminate but the driver will feel the brake pedal pulsating and may hear an audible sound from the modulator indicating that ABS control is taking place.

ABS and EBD Warning Lights:

The ABS and EBD warning lamps will illuminate for a system check for approximately 3 seconds, when the ignition is switched 'ON'. Both lamps will then go 'OFF' to indicate the system is healthy. As the EBD lamp is shared with the Park brake lamp & brake fluid level warning, so this will not go 'OFF' until the park brake is released and fluid level in reservoir is approximately at Max Level.

CAUTION

In case of an 'ABS' or 'EBD' failure the warning lamp will illuminate in instrument cluster. In that case please pull over the vehicle to the side of road and switch off the ignition and restart.

If the fault persists, your brake system may not be working properly, hence it is dangerous to drive the vehicle. However if you feel and judge that it is safe to drive, then take the vehicle carefully to the nearest TATA authorised Service station for repair. Otherwise get your vehicle towed as driving the vehicle with this fault could be dangerous.

WARNING

- 'ABS' is an aid to retaining steering control and stability while braking.
- 'ABS' will not prevent accidents resulting from excessive cornering speeds, following another vehicle too closely or aquaplaning, i.e. where a layer of water prevents adequate contact between tire and road surface
- 'ABS' will not improve braking performance or stopping distance beyond that which is physically

possible which is constrained by the road conditions, vehicle's tyres and brakes.

- The additional control provided by, 'ABS' must never be exploited in a dangerous or reckless manner which could jeopardise the safety of driver, other road users or pedestrians.

Electronic Stability Program (if equipped):

The Electronic Stability Program (ESP) monitors information from various vehicle sensors and then compares the driver's commands with actual behavior of the vehicle. If an unstable condition occurs like a sudden evasive movement, ESP intervenes within fraction of seconds via Engine Control Unit, Brake system & TOD Transfer case (if equipped) and attempts to stabilize the vehicle. ESP also assists in maintaining traction while accelerating on loose or slippery road surfaces.

⚠ CAUTION

In case of an ESP system failure the warning lamp will illuminate in instrument cluster. In that case please pull over the vehicle to the side of road and switch off the ignition and restart. If the fault persists, your ESP system may not be working properly, take the vehicle carefully to the nearest TATA authorised Service station for repair.

NOTE

During Engine Cranking ESP warning lamps might glow for a few seconds.

ESP Indicators :

When ignition is turned ON, the ESP indicator on the instrument cluster glows for a few seconds and goes OFF. If the ESP indicator does not come ON or remains ON when the ignition is turned ON, there may be a fault in the ESP system. In such a case, please take your vehicle to a Tata Authorized Service station immediately.

ESP Operation:

During ESP intervention the following actions may occur;

- ESP indicator starts flashing.
- A slight noise from ESP / ABS modulator may be heard, which is only the effect of brake control and indicates nothing unusual.

- Engine may not respond to accelerator in the usual way.
- Cruise Control Setting gets disabled.

WARNING

ESP is just a driving aid; it cannot enhance your vehicle's stability in all conditions and does not control your car's entire braking system. It is still your responsibility to drive and corner at reasonable speeds and leave a sufficient margin of safety. Always use precautionary measures for safe driving by slowing down on curved, snowy or icy roads.

ESP and tyre sizes:

If you drive your vehicle with a non specified tyres or wheel sizes, the ESP system may not work properly. When replacing tyres, always ensure to use only recommended tyre sizes.

Cruise Control (if equipped):

Cruise Control is a user friendly function meant to reduce driver fatigue, especially when traversing long distances. The Cruise Control System allows you to program your car to maintain a constant / desired speed without resting your foot on the accelerator pedal.

Cruise Control can be activated in following gears and speeds :

Gear	Allowable Speed Range (km/h)
1st Gear	No cruise control
2nd Gear	No cruise control
3rd Gear	32 - 110
4th Gear	38 - 150
5th Gear	45 - 160

WARNING

If Cruise Control function is not used properly, it can be dangerous and may cause an accident.

Do not use the Cruise Control function on busy, winding and slippery roads, for going up or down a hill, and in heavy rain or bad weather. Use only when traveling on open highways in good weather.

Cruise Control Switch on Steering Wheel :

1. Cruise setting / Speed decreasing switch
2. Cruise resetting / Speed increasing switch
3. Cruise control cancelling switch

Cruise Control Master Switch on Combi-Switch :**Using Cruise Control:****Step 1: Activating Cruise Control**

Cruise Control Master Switch is located on the right stalk of combi switch. Rotate the switch to "ON" position.

Step 2: Setting Cruise Speed

Attain the desired speed manually and press the "SET" button on Steering wheel switches to set the desired Cruise Speed. The cruise indicator  on instrument cluster will come "ON" to indicate that the vehicle is in Cruise

Control Mode. Now you can release the accelerator pedal.

Step 3: Changing the set Cruise speed

The set cruise speed can be adjusted (i.e. increased or decreased) using '+' (to increase) and '-' (to decrease) buttons on Steering wheel. The set cruise speed increases and decreases by 2 kmph on single press, the '+' & '-' button is pressed. The changed speed will be shown on the speedometer. Keeping the button pressed, increases or decreases the speed continuously till the button is released. The set speed can also be increased by pressing the accelerator pedal till the desired speed is achieved and then pressing the "SET" button. The set speed can also be decreased by pressing the clutch or brake pedal (The cruise indicator will go off) and slowing down to desired speed and then pressing the "SET" button (The cruise indicator will come "ON" again).

Step 4: Canceling the cruise control:

Cruise control can be cancelled in three ways:

- Depressing Clutch or Brake Pedal.
- Pressing the "CANCEL" button on Steering Wheel.
- Turning "OFF" the Cruise Switch on the Combi switch.
- Cruise control gets cancelled when ESP/ TCS system is active.

Step 5: Resuming the Set Cruise Speed :

Cruise speed can be resumed only if cruise control is cancelled by depressing Clutch or Brake Pedal. To resume the previously set cruise speed, accelerate the vehicle to a speed above 35 kmph and press "RES" button.

CAUTION

Cruise Switch on combi switch must always be in "OFF" position when not in use.

NOTE

- While going up or down on a slope (e.g. hill), Cruise Control may not be able to maintain the SET speed and may be deactivated. Cruise Control can be reactivated using 'SET / RES' button provided on steering wheel. In such cases use accelerator for increasing speed (when going up) and brakes to decrease (when going down). If brakes are used Cruise Control is turned off.
- Even when your Vehicle's Cruise Control is ON, you can use the accelerator to increase its speed, especially while overtaking. Once you take your foot off the accelerator pedal, the Vehicle will return to the set cruise speed.
- In order to decrease the speed quickly, use the brakes as you normally do.
- Cruise Control will be cancelled if you rest your foot on the clutch or brake pedal.

Torque - On - Demand (TOD) Transfercase : (If Equipped)

The “TOD” is a part time Torque on demand Transfer case, responsible for distributing torque between the front and rear axles. The Torque-On- Demand system is an electrically actuated clutch mechanism that is used to control the speed differential of the front and rear outputs of a transfer case. According to the driving conditions this system automatically and smoothly delivers two-wheel / four-wheel drive operations with the help of ECU & Electromagnetic clutch. In 4 X 4 / Auto mode, whenever any slippage is detected in the rear wheels (*in icy roads, wet surfaces, etc.*) the torque is transferred to the front wheels by the TOD system.

Using TOD system:

TOD System provides two operating positions i.e. 4 X 2 Mode and 4 X 4 (Auto) mode.

To activate **4 X 2 mode**, press “4 X 2” switch provided on your vehicle’s facia,

the **LED** on the switch turns “**ON**”. In this mode, the engine power is supplied to the rear wheels only.

To activate **4 X 4 / Auto mode**, again press “4 X 2” switch provided on your vehicle’s facia, the **LED** on the switch goes “**OFF**”. In this mode, the engine power is supplied to both front & rear wheels, based on the driving conditions.



At Ignition On , TOD shall attain the mode (4x4 or 4x2) that it was in when you last switched OFF the ignition.

TOD Indicator:



TOD indicator turns “ON” when there is a malfunction in the TOD system. In such a case, please take your vehicle to a Authorized Service station.

NOTE

When TOD is in “4 X 4 / Auto” mode & Ignition switch is in “ON” position, you will hear a slight noise from the Axle connect mechanism. Similarly you will hear same noise while changing over from 4 X 2 to 4 X 4 / Auto mode and vice-versa.

CAUTION

While changing over from ‘4X2’ to ‘4X4/AUTO’ or vice-versa, the vehicle speed should be below 80kmph.

RAIN & LIGHT SENSORS :(If fitted)

Your vehicle is fitted with a Rain & Light sensor, just below the wind screen and above the dash board.



Auto front wipe function: (If Fitted)

The Rain sensor is an optical system that automatically operates your vehicle's wipers when it detects raindrops falling on the windscreen. The Auto front wipe gets enabled only when you keep the left hand side wiper stalk in the Auto position and ignition is "ON".

Auto wipe has 4 positions and 3 wiper speed settings:



Wiper Speed settings

(Vehicles having Auto Front wipe will not be fitted with an intermittent wipe speed selector).

The wiper stalk will also provide five; rain sensitivity/frequency settings to allow you to select the sensitivity of the auto wipe system. **P1, P2, P3, P4 & P5** are the different sensitivity levels that you can select from the left hand stalk of Combi Switch. P5 is the lowest sensitivity and P1 the highest sensitivity mode.



P1, P2, P3, P4 & P5 levels



These will vary the amount of rain that must be detected by the rain light sensor before the auto wipe system turns "ON". The speed of wiping will be varied depending on the intensity / frequency of rain falling.

NOTE

In case of loss of signal from the Rain and Light sensor, the wipers will sweep in different interval mode as per the sensitivity you select or, till a valid signal is received from the Rain Light sensor.

Auto Light function :

- The light sensor is an optical sensor that automatically switches “ON” or “OFF” the head lamps whenever it senses the surrounding light intensity. (e.g. when the vehicle enters a tunnel or when it is twilight).
- Auto Light function is activated if the auto light switch is in auto mode on the Master Light switch.

NOTE

In case of loss of signal from the Rain and Light sensor, the low beam and parking lights will be ‘ON’ automatically. Also user can operate manual high beam through combination switch. In case of major electrical failure, manual high beam cannot be operated.

Reverse Guiding System : Parking Distance Control with Camera (if equipped) :

This system consists of a rear view camera mounted below chrome garish on the tailgate and a display monitor on the centre console of the dashboard.



Ultrasonic sensors fitted on rear bumper

The monitor turns 'ON' automatically when the ignition is 'ON'. After engaging reverse gear, the camera provides you with a wide view of what is behind your vehicle. It reduces the risk of colliding against anything that is not easily visible from the vehicle's rear view mirrors.



Rear view on TFT screen

CAUTION

- Parking aids is for guidance only, and are not intended to replace the driver's visual checks for obstructions when maneuvering.
- Always be vigilant when reversing.
- It is driver's responsibility to detect obstacles and estimate the vehicle's distance from them while reversing. Some overhanging objects or barriers, which could possibly cause damage to the vehicle, may not be detected by the camera.

The camera can view 92° vertical view angle and 124° horizontal view angle.

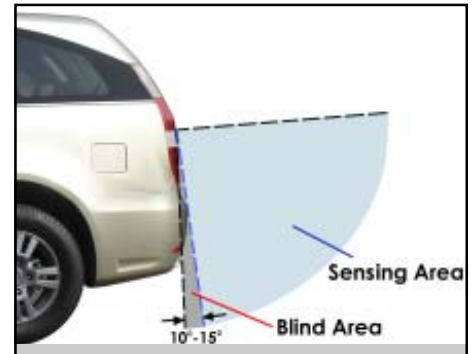
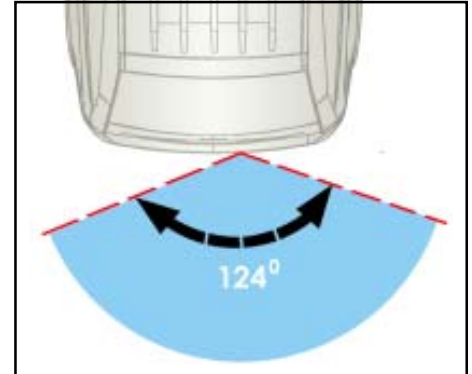

Parking Distance Control with Sensors (if equipped):



Ultrasonic sensors fitted on rear bumper

Ultrasonic sensor based reverse guiding system is designed to aid safe driving while reversing the vehicle. The system alerts and show you the distance from obstacles while reversing the vehicle at low speed. It includes four sensors, a controller, buzzer and a display. The system is designed to give both audible and visual signal, when the rear bumper of the vehicle comes closer to an object. The system is automatically activated when the reverse gear is engaged.

Operating Instructions

1. Switch 'ON' the ignition, display will show the TATA logo indicating the system is working fine. On engaging the reverse gear, system will get activated automatically. When the obstacle comes in the sensing zone, system starts giving an audio & display indication.

2. Buzzer ON / OFF switch

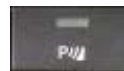

Buzzer ON / OFF switch is located on facia switch (below Infotainment system) is a master switch. Park assist system enables the Buzzer automatically on every ignition cycle.

Buzzer	LED
Enabled	ON
Disabled	OFF

Buzzer is used for audible warning which is controlled by buzzer ON / OFF switch. Buzzer sound time duration depends on the obstacle distance. Buzzer can be switched 'OFF' by pressing this switch.

NOTE

Please note, objects less than one metre in height and 20 mm width / diameter may not be detected by the Reverse Parking Sensor.

Zone	Distance Between Obstacle & Rear bumper	Buzzer beep Frequency
1	120 cm	Low frequency
2	80 cm	High frequency
3	40 cm	Continuous beep
4	30 cm	Not guaranteed



CAUTION

1. In case of bumpers fitted with ultrasonic sensors (4 Nos), the system performance is dependent on the reflection of ultrasonic waves from the obstacle.
2. **System cannot sense**
 - a) Wire mesh, handrail, small objects & some obstacle which are coming too much below or too much above the bumper level.
 - b) Obstacles like cotton, wool, foam, textile or spongy surface which will absorb ultrasonic waves easily.
 - c) Pot holes or the trenches or drainages which are below the ground level.
3. **System may give wrong signal on reversing :**
 - a) When the vehicle on grasslands & bumpy roads.
 - b) While vehicle moving from plain ground to slope like backing up downhill or vice versa.

- c) When the bumper is tilted more than the normal position or when the vehicle is heavily overloaded.
 - d) When the temperature of the obstacle is high as hot surfaces reflect fewer sound waves less than cold surfaces.
 - e) If there is an excessive increase in humidity as it increases the sound speed (max. by 2%) as compared to dry air.
 - f) When the vehicle is equipped with high power radio antenna on rear side.
 - g) If sensor is at extreme temperatures: below -30°Celsius or above 80°Celsius.
4. System may give false alarm during the heavy rain conditions, during the snow conditions or heavy wind conditions.

WARNING

1. This system is strictly a driver assistance device. It is not a substitute of driver's responsibility while driving. Under no circumstances will the manufacturer accept any responsibility or can be held liable for any direct or indirect, incidental or consequential damage caused by negligent use of this system.
2. Clean the sensors properly and keep them free from ice, dust, mud, water, chewing gum etc. for proper working of the system.
3. Please practice reverse parking using different obstacles to grasp the system performance.
4. Pressing the sensor on active region may damage the sensors & may hamper its sensing range causing the system to malfunction.
5. Always STOP your vehicle when a continuous beep is heard. As it

indicates an object at dangerous distance not more than 1M from the rear bumper.

- Never use high pressure water to clean the sensors and also never use hammer on it.

4. Graphics on LCD:



LCD display graphic representation for the obstacle coming close to the bumper are shown below :



Just Detected



Sensor Malfunction

SAFETY CHECKS BEFORE DRIVING:**Check :**

1. Tyre pressure and condition of tyres.
2. Coolant level.
3. Engine oil level.
4. Brake fluid level.
5. Water in windshield washer reservoir.
6. Power steering oil level.
7. Battery electrolyte level.
8. Ensure sufficient Fuel.

Adjust:

1. Adjust your seat position.
2. Check adjustment of all rear view mirrors.
3. Check and adjust steering height.

Ensure:

1. Bonnet is properly closed and locked.
2. All doors are properly closed and locked.
3. Check that the items you may be carrying inside with you are stored properly or fastened securely.

4. Seat belts are fastened.
5. All mirrors, windows and outside lights are clean and unobstructed. Remove dust, frost, snow or ice if any, on these.
6. All switches and lamps are working
7. All the gauges and indicators in the instrument cluster are working.
8. Gear shift lever is in neutral position.
9. Parking brake is released.

Windshield/wiper/windshield washer:

Always keep windshield glass clean to avoid any distortion in visibility. Ensure proper working of wipers and condition of wiper blade. Ensure that windshield washer reservoir is full. Do not operate wiper alone when the windshield glass is dry, this may damage the windshield.

Headlights:

Keep headlight lenses clean. Check for operation of headlamps in both high/low beam condition. Check for correct focusing of headlamps. Use only

recommended type of bulbs. Do not use the high beam unless it is inevitable, as its dazzle may glare the driver of an oncoming vehicle, thus causing an accident.

Side indicators / Hazard warning:

Ensure that all side indicators/ hazard warning lights are in working condition and they are used when required.

Horn:

Ensure the horn is working properly. Horn provides safety to other road users by alerting your presence.

Brakes:

Ensure brakes are working properly. Do not drive the vehicle when brake warning lamp is 'ON'.

Tyres:

Check the condition of tyres for any abnormalities. Maintain correct tyre pressure. Do not use worn or bald tyres, especially on the front wheels.

First Aid Kit:

A first aid kit is provided in your vehicle. This is for use in case of minor injuries. It should be regularly checked and updated.

Documents:

Always carry car registration papers, insurance, valid PUC certificate and driving license with you.

DRIVING SAFETY :**Seat Belt:**

Seat-belts are life saving equipment. Use of seat-belt reduces the chance of injury and severity of injury in case of an accident. It is strongly recommended that all the vehicle occupants always wear seat-belts when car is in motion.

Influence of Alcohol / Drugs:

Avoid driving under the influence of alcohol or drugs. Alcohol and drugs will severely affect your reflex actions. This will impair your control of the car and increase the risk of injury to yourself and others.

Mobile phones:

Avoid using mobile phones while driving a vehicle. This could divert your attention from the road and result in an accident.

Fatigue 'Rest Revive Survive':

Do not attempt driving when you feel tired, sleepy. Long distance driving can tire you very much and fatigue can dull your reflexes and judgment. Take rest and get refreshed at regular intervals.

Parking on slopes:

While parking, if your vehicle facing uphill, it is advisable to switch off the engine and engage reverse gear.

While parking, if your vehicle facing down hill, it is advisable to switch off the engine and engage lower forward gear.

Fuel economy :

Your vehicle's fuel economy depends mainly on your style of driving, where you drive and when you drive.

Each of these factors affects how many kilometers you can get from a litre of fuel. To operate your vehicle as economically as possible, the driving suggestions below will be useful.

- Do not warm up your vehicle's engine for a long time. Start driving once the engine is running smoothly. Engine warm up may take a little more time on colder days.
- Gently press the accelerator pedal after stopping
- Get your vehicle serviced as per the Service Schedule. This not only increases the life of all parts but also lowers your operating costs.
- Avoid using the Air Conditioner unnecessarily

- Lower your vehicle's speed when driving on rough roads.
- Keep the tyres inflated to their recommended pressure. This also helps in better tyre life and fuel economy.
- Maintain a safe distance from other vehicle's to avoid sudden stops. This will reduce wear on brake linings and pads. Driving in such a way will also save fuel because extra fuel is required to accelerate back to driving speed.
- Do not carry unnecessary weight in your vehicle.
- Do not rest your foot on the brake and clutch pedal while driving. This causes brakes and clutch to wear out faster. Your car's fuel economy is also affected.
- Improperly aligned wheels result is uneven tread wear and poor fuel economy. Check your car's wheel alignment regularly.

- As far as possible roll up your vehicle's windows when traveling at high speeds. This improves the fuel economy of your car.
- Reduce your vehicle's speed when the wind is blowing against the direction in which your car is going.

Gear	Running-in speeds (Kmph)		Fuel Economy speeds (Kmph)	
	4X4	4X2	4X4	4X2
1st	20	20	-	-
2nd	40	35	30	30
3rd	60	55	40	40
4th	80	75	50	50
5th	110	100	60	60

Starting the Engine:

- Ensure that the vehicle is in Neutral gear for safe starting.
- Do not press the accelerator pedal.
- Wait till glow plug indicator goes OFF
- Keep the clutch pedal fully pressed and crank the engine. Release the key as soon as engine starts. While cranking, all accessories will be momentarily 'OFF'.

NOTE

The Starter Protection System fitted in this vehicle does not allow you to crank the engine until you fully press the clutch pedal.

- If the engine does not start immediately, hold the ignition key at crank position for 10 secs. This will help to start the engine if starter motor is in fail-safe condition operation.
- In case of unsuccessful/delayed engine start, kindly contact authorized

TATA MOTORS Service Centre

Starter Protection system:

This Starter Protection system provides the following safety conditions :

1. Automatic disengagement of starter motor once the engine is started to avoid over-running of starter motor
2. Not allowing starter motor to engage when engine is running
3. No starter motor function when vehicle is in running condition.
4. Not allowing starter motor to crank the engine under low battery condition (below 6.5V) to avoid further draining of battery

NOTE

After starting, run the engine in idle speed for at least 30 seconds. Do not press accelerator pedal while starting the engine to avoid damage to turbocharger (in case of diesel cars).

Stopping the Engine:

Before switching OFF the engine, run the engine in idle condition for atleast 30 seconds and then switch OFF. This will allow the engine oil to lubricate the turbocharger, till its speed is fully reduced and also allow the unit to cool down.

The above precautions will ensure satisfactory life and performance from the turbocharger.

Preparing to Drive :

- Release the parking brake.
- Before entering the vehicle, check and clear any obstructions that may not be visible from the driver's seat.
- Before driving off check in the rear view mirror, for oncoming traffic. Switch on side indicator signal when getting into main stream of traffic.

Parking :

- Park the vehicle in a safe place.
- Apply the parking brake.
- Ensure that all window glasses are closed and all lamps are turned OFF.
- At night, put on the parking lights if required.
- Remove the key from the ignition switch.
- Place wheel chocks at the wheels if parked on a slope.

 **CAUTION**

- Do not leave the key inside the vehicle.
- Do not leave children unsupervised inside the vehicle.
- When parking on a level ground, you may place the gear lever in "Neutral" position. When parking on a downhill gradient, place the gear lever in 'Reverse' position. When parking on uphill gradient, place the gear lever in the '1st' position.

Running-in Period:

Avoid rapid acceleration and prolonged high speed running of the engine while using the new vehicle for the first 1500-1800 km of operation.

Do not exceed the following road speeds during running in period.

Gear	Running-in speeds (Kmph)	
	4X4	4X2
1st	20	20
2nd	40	35
3rd	60	55
4th	80	75
5th	110	100

Before you shift to reverse gear, bring your vehicle to a complete stop and depress the clutch pedal fully.

Do not shift into reverse gear when the vehicle is moving forward.

While shifting the gears, it is recommended to shift at the speeds given in the table.

You can get extra braking from the engine when slowing down by shifting to a lower gear.

This can help you to maintain a safe speed and prevent your brakes from overheating while going down a steep hill.

**CAUTION**

- Avoid excessive revving up of engine rpm.
- Idling the engine for long duration must be avoided.

Gear Shifting Speeds :

Gear	Vehicle Speeds During Upshit
1st - 2nd	20
2nd - 3rd	40
3rd - 4th	60
4th - 5th	80

Gear	Vehicle Speeds During Downshit
2nd - 1st	15
3rd - 2nd	30
4th - 3rd	45
5th - 4th	70

NOTE

While driving at higher gears, if the engine speed suddenly drops, the engine may stall and will be switched 'OFF'. This is done to safe guard the transmission system.

Brakes :

The brake system on your vehicle is an advanced dual circuit, vertical split vacuum assisted hydraulic brake system.

It is equipped with:

- Brake booster: This assists the driver in braking with an ergonomic pedal force on brake pedal;
- Tandem Master Cylinder, for fail safe braking.
- Twin pot calipers in front and single pot callipers in rear, for efficient energy absorption.

However, in failure of one circuit, the pedal will be lighter to press, pedal travel will be higher and stopping distance will increase. At the same time brake indication light would glow on dash board.

If you observe any abnormality in brake system, contact your nearest **TATA** Authorized Service Centre. In case of failure of vacuum supply to the brake booster the car can still be

stopped with a higher pedal effort. In case of vacuum failure or brake circuit failure, slow down the vehicle by shifting to lower gear and lifting your foot from the accelerator pedal. Pull to the side of the road as soon as it is safe. Put your foot on brake pedal to apply brake. Do not ride with brakes applied as they may overheat and the performance may be impaired. The brake lights may confuse the other road users behind you. Use engine to assist the brakes by shifting to a lower gear and lifting your foot from accelerator pedal.

Constant application of brakes while going down the hill builds heat and reduces braking efficiency.

Check your brakes after driving through deep water. Apply the brakes moderately to feel that they are normal. If not, apply them gently and frequently until they do. With wet brakes you should be extra cautious and alert while driving.

 **CAUTION**

Brake system failure is hazardous and needs immediate attention. In the event of brake system failure,

- a) Have your vehicle towed OR
- b) Be extremely cautious in case you have to drive the car.

Driving Through Water :

Never venture to drive through water when it flows over stones on a bridge.

Your vehicle's engine may get seriously damaged if attempted to drive through deep water.

If at all the situation demands that you have to drive through water then;

- Keep engine in fast idling and crawl the vehicle in low gear.
- After driving through water apply brakes several times to dry liners and to regain original braking.
- Do not attempt to start the engine if vehicle gets flooded due to water. Tow the vehicle to a safe place.
- Take the vehicle to nearest **TATA MOTORS** authorised workshop to check entry of water in cylinders.

- If water has entered the engine or transaxle, the lubricants will have to be replaced.
- Get the starter and alternator checked.

Driving on a Rainy Day :

- Check brakes, steering and windows. Check tyres for wear and tyre pressure.
- Check wiper blades for proper functioning.
- Avoid harsh braking and sharp turns. It may cause loss of control and lead to a skid.
- For slowing down, shift to lower gears and brake gently.
- Keep head lights ON if visibility is poor.

Night Driving :

- Dip the head lamp for oncoming traffic during night driving.
- Maintain a speed such that you can stop within illuminated distance of head lamps.
- Use head lamp main/dip beam to alert other road users on turns/cross roads etc.
- Use side indicators for lane change or turning. Put ON hazard warning switch in case of hazardous parking or if your vehicle is disabled to warn the passing traffic.

Climbing Sharp Gradients on Loose Surfaces:

- Start off smoothly in any suitable gear. Apply power smoothly so that there is no loss of traction by over-revving of the engine.

- Choose as smooth a slope as possible and select the appropriate gear so that gear changing in the middle of the climb is not required.
- Changing gears in the middle of the climb can cause loss of momentum and engine stalling. Shifting to a lower gear has to be done cautiously to avoid loss of traction.
- Never move the vehicle diagonally across a hill. The danger is in loss of traction and sideways slippage, possibly resulting in tipping over. If unavoidable, choose as mild an angle as possible and keep the car moving.
- If the wheels start to slip within few feet of the end of the climb, motion can be maintained by swinging the steered wheels left and right, thereby providing increased grip.
- If the vehicle stalls or loses headway while climbing a steep hill, make a quick shift to reverse and allow the car to move back with the control of engine compression.

Descending Sharp Gradients :

- Depending on the severity of the gradient, shift into appropriate gear. Use engine braking judiciously without over-revving the engine.
- Brake application under such situations should be done very smoothly to avoid loss of control. Select appropriate gear so that gear changing or clutch disengagement is not involved while descending the gradient.

Advance Warning Triangle :

The advance warning triangle is kept below the 3rd row seat with the help of velcro strap.

Jack :

The jack is kept in the rear luggage space of your vehicle. Open the tail gate and lift the cover of the storage box to access the scissor jack.

Tools :

Following tools are provided with your vehicle.

1. Wheel Spanner
2. Extension Rod for spare wheel removal
3. Reversible Screw Driver
4. Handle for operating jack
5. Tow Hook

While jacking the vehicle, occupant have to fix the wheel spanner with jack handle.

For fixing the wheel spanner with jack handle align the spring loaded ball provided on jack handle with notch on wheel spanner and then insert.

Kindly refer operating instructions provided on the sticker, which is fixed on the jack itself.

IF YOU HAVE A FLAT TYRE

Reduce vehicle speed gradually keeping it is a straight line. Move cautiously off the road to safe place away from traffic. Park the vehicle on a level and firm ground. Apply parking brake and engage 1st gear.

Turn on Hazard warning switch. Keep advance-warning triangle at least 50 meters behind the car as an indication of breakdown.

Take out the tool kit, jack and handle from the car which is kept in the luggage compartment.

Removal of Spare wheel:

Spare wheel is located below the rear luggage space floor and behind rear bumper.

Spare wheel removal procedure :

1. Open the tail gate and storage box cover, remove the anti-theft rubber lock.



2. Remove the window cover provided on the rear bumper to access the spare wheel bracket.
3. Insert the spare wheel handle with extension through the window.



4. Rotate the handle anti-clockwise to lower the spare wheel till it rests on the ground.



5. Remove the holding bracket from the spare wheel and get the spare wheel separated.



Jacking the vehicle and changing wheel:



Jacking Point - Front



Jacking Point - Rear

While jacking the vehicle, following precautions are to be taken :

1. Park the vehicle on a firm, leveled and non-slippery surface.
2. Turn ON hazard warning switch.
3. Apply parking brake and engage 1st gear.
4. Keep advance-warning triangle at least 50 meters behind the vehicle as an indication of breakdown.
5. Ensure that the all passengers get down from the vehicle.
4. Block the wheel which diagonally opposite to the flat tyre by using chocks.

After confirming the above conditions, you can go for jacking up the vehicle.

Set the jack properly at correct jack point as shown for front or rear wheel. The jacking points are located approximately 950 mm behind the front wheel and 700

mm ahead of the rear wheel. Slowly lift the vehicle with the help of jack handle. Remove wheel-mounting nuts and take-out flat tyre.

Roll the spare wheel into position and align the holes in the wheel with studs. Reinstall the wheel nuts (taper end inward) and tighten them as much as you can by hand.

NOTE

Before using the jack, please read the instructions on the sticker provided on the jack.

Lower the jack completely and tighten the wheel nuts one by one using wheel spanner. Press fit the wheel cover back (if fitted).

Restore all the tools and jack at their respective location.

Place the flat tyre at spare wheel location and place the anti-theft lock to its place.

CAUTION

Check and correct tyre pressure and nut tightness of the changed wheel as per recommendation at a nearest service station. Get the flat tyre repaired at the earliest.

Towing the Car :

- For towing a car, the best way is to use a wrecker.
- Alternatively, use a rigid tow bar.
- Avoid using a flexible cable or rope as your car may crash into the car towing your car when it stops suddenly.
- Switch ON the hazard warning signals of both the cars to warn other road users.
- Where possible, keep the engine idling so that power steering assistance and brake vacuum are available.
- Limit the speed to 20-30 kmph.
- In case of brake failure, use the parking brake to control the car.

Location of Tow Hooks:*Tow Hook Attachment Location at Front**Tow Hook Attachment Location at Rear*

In Case of Emergency :

Your ARIA is fitted with an Inertia Switch, which will trigger if the vehicle is brought to an abrupt halt, normally during a collision. Normal driving and even sudden braking will not trigger the inertia switch.

When the Inertia Switch is triggered the following will happen

- All the doors will be unlocked.
- All the turn indicators will flash (both Left Side and Right Side).
- All the roof lamps will be turned ON.

To undo the above affects you have to reset the Inertia Switch as shown below.

WARNING

After resetting the switch and before resuming driving, check for any damage to the body or check if any part is hanging loose. Also, after turning ON the ignition, ensure that no faults are displayed in the instrument cluster

Resetting the Inertia Switch :

1. Open the Front Right Door (for LHD Models). And reach out in the area below the glove box as shown in the image below.



2. Reach out for the Inertia Switch through cut-out (opening) and press it.



NOTE

Although the Inertia switch cannot be seen, it can be easily located by the cut-out (opening) provided in the top of the lower A' Pillar trim.

Starting the Engine with Jump Leads:

The engine with a discharged battery can be started by transferring electrical power from the battery of another vehicle. This may be dangerous as any deviation from the following instructions could lead to personal injury resulting from any battery explosion, as well as damage to the electrical systems in both vehicles.

CAUTION

Do not allow battery electrolyte to come in contact with eyes, skin, fabrics or painted surfaces. The fluid contains sulphuric acid which can cause injury and severe damage. Wear rubber gloves, to avoid risk of contact.

- Wear eye protection when working near any battery.
- Make sure that the battery providing the jump start has the same voltage as the battery in your vehicle (12V).

The voltage and capacity are given on the batteries.

- Do not disconnect the discharged battery from the vehicle.
- Switch off all unnecessary electrical loads.
- Do not lean over the battery during jump starting.
- Do not allow the terminals of one lead to touch those of the other lead.
- Apply hand brake. Keep the gear shift lever in neutral.
- Do not connect the lead to the negative terminal of the discharged battery.
- The connection of the -ve lead point should be as far away from the discharged battery as possible and close to the starter motor.
- Route the leads so that they do not get caught by the rotating parts in the engine compartment.

Connect leads in the order as shown in the sketch

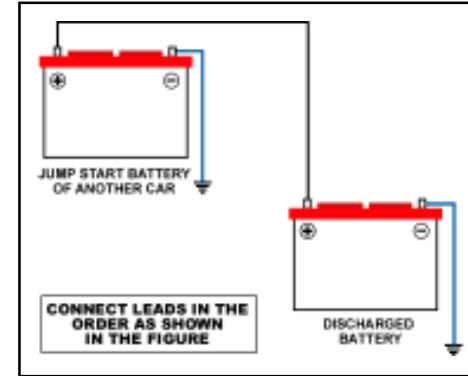

Attempts to start the engine of the vehicle with the discharged battery should be made at intervals of one minute and should not last more than 15 seconds. After starting, allow both engines to idle for approximately 3 minutes with the leads still connected.

CAUTION

Do not push start the vehicle, this may damage flywheel.

FUSE AND RELAY BOX DETAILS:

The fuses & relays are located in three fuse boxes:

1. Battery mounted fuse box is mounted in the battery in the engine compartment.
2. Engine compartment fuse box and relay box is located in engine compartment.
3. Cabin wiring harness fuse and relay box is located under the dashboard on driver's side.

Location of the three fuse boxes in your car

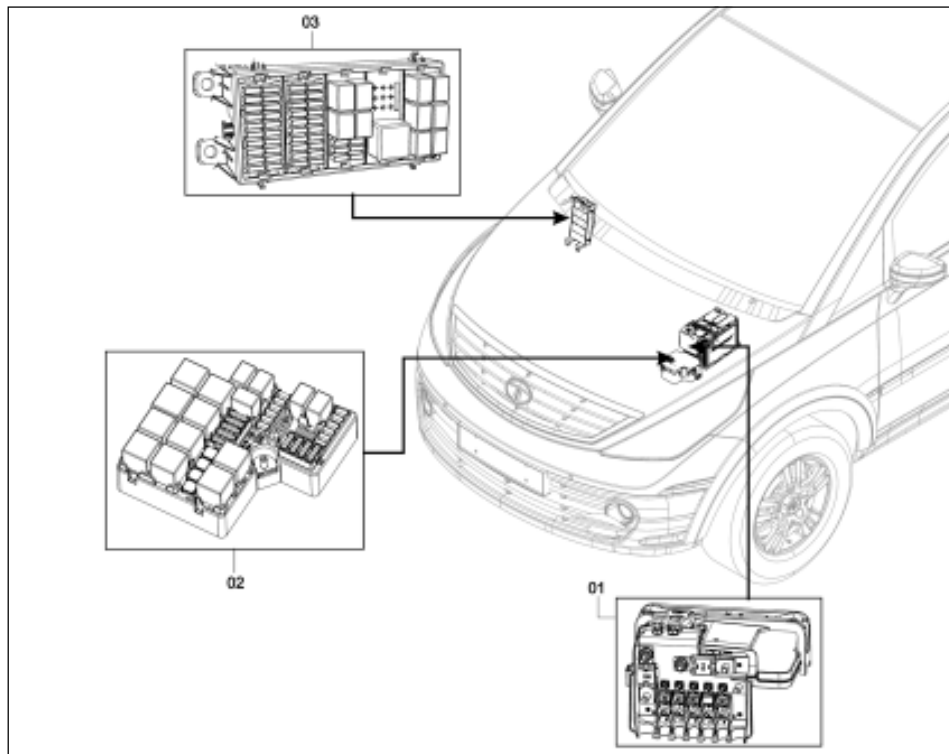

1. ENGINE COMPARTMENT FUSE AND RELAY BOX

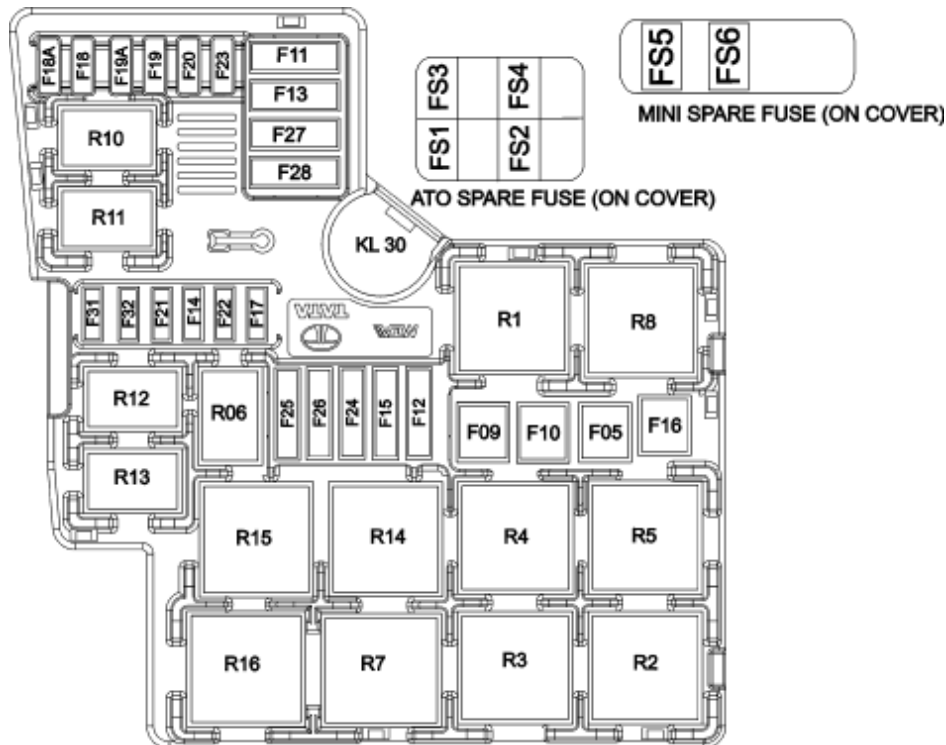

NO	RATING	POWER CONSUMER
R1		Accessories
R2		Cooling Fan II
R3		Cooling Fan I
R4		Cooling Fan III
R5		Heater Rear Screen
R6		Aircon
R7		EMS Relay
R8		Starter
R10		Dip Beam
R11		High Beam
R12		Horn
R13		Front Wiper
R14		Glow Plug I
R15		Front Fog Lamp
R16		Glow Plug II
F5	60A	Accessories
F9	40A	Cooling Fan II
F10	30A	Heater Rear Screen
F11	20A	TOD
F12	40A	HVAC
F13	25A	ABS/ESP
F14	15A	Aircon
F15	30A	EMS
F16	40A	Starter
F17		Not Used
F18	10A	Dip Beam RH
F18A	10A	Dip Beam LH

NO	RATING	POWER CONSUMER
F19	10A	Main Beam RH
F19A	10A	Main Beam LH
F20		Not Used
F21	10A	Horn
F22		Not Used
F23	15A	Rear Wiper
F24	40A	Glow Plug I
F25	15A	Front Fog Lamp
F26	40A	Glow Plug II
F27	15A	Tow Bar
F28	30A	HAS Batt
F31	10A	AMPS
F32	15A	At Batt
FS1	20A	SPARE
FS2	40A	SPARE
FS3	25A	SPARE
FS4	30A	SPARE
FS5	15A	SPARE
FS6	10A	SPARE

2. BATTERY MOUNTED FUSE AND RELAY BOX

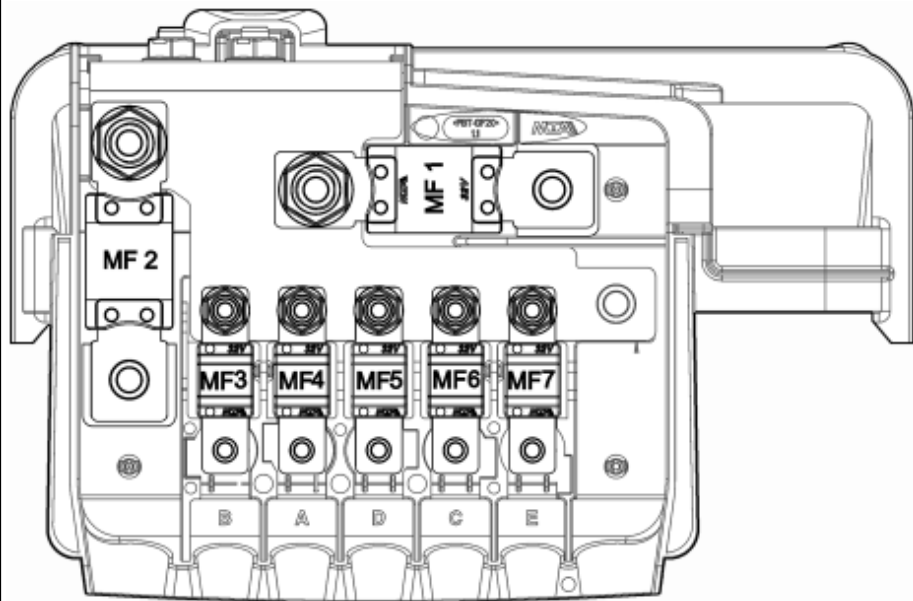

NO	RATING	POWER CONSUMER	NO	RATING	POWER CONSUMER
MF1	CAL 5	STARTER MOTOR	MF5	60 A	IGNITION
MF2	150 A	ALTERNATOR	MF6	-	Not in Use
MF3	60 A	BATTERY COCKPIT	MF7	30 A	COOLING FAN
MF4	40 A	ABS/ESP			

3. CABIN WIRING HARNESS FUSE & RELAY BOX UNDER THE DASHBOARD ON DRIVER SIDE (RIGHT SIDE)

This fuse box is part of main wiring harness.

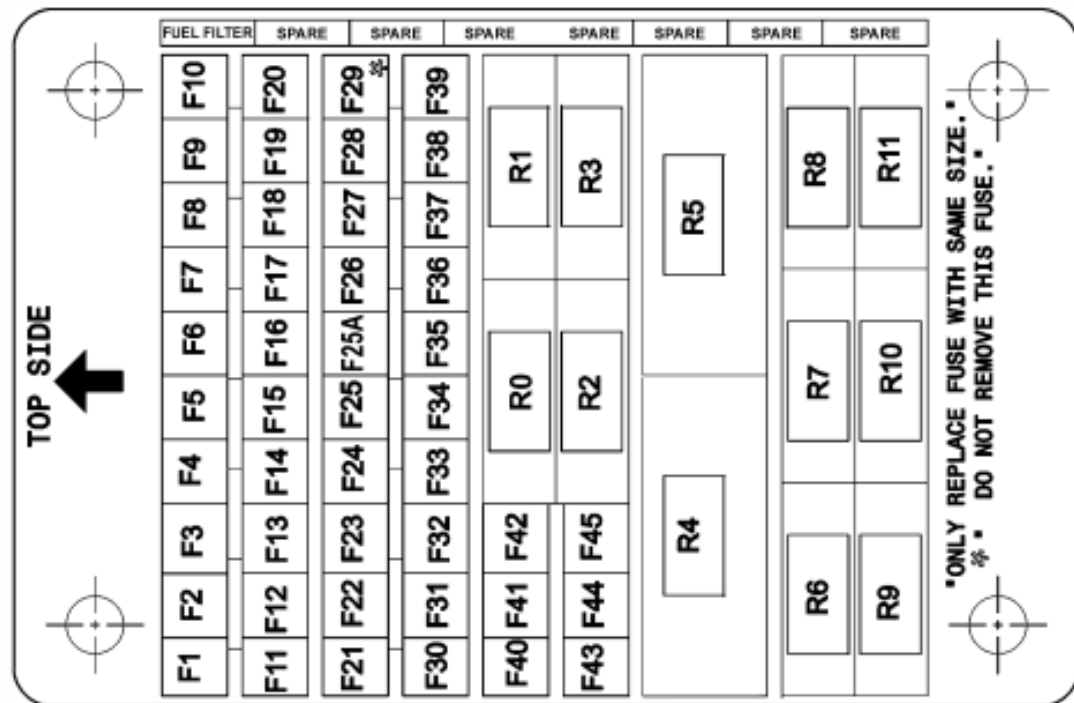

NO	RATING	POWER CONSUMER
F1	25A	W/W FR RH BATT.
F2	10A	USB,TFT & BT BATT
F3	5A	MASTER LIGHT SW BATT.
F4	5A	HAVC BATT.
F5	20A	INFOTAINMENT BATT.
F6	25A	W/W RR LH BATT.
F7	25A	W/W RR RH BATT.
F8	10A	INTERIOR LAMP
F9	10A	IMMO & KEY IN BATT.
F10	10A	INSTRU CLUS BATT.
F11	10A	PARK LH
F12	10A	PARK RH
F13	10A	MIRROR HEATER
F14	20A	HEATED REAR SCREEN
F15	5A	EMS DIAGNO INERTIA SW BATT.
F16	20A	CENTRAL DOOR LOCK BATT.
F17	10A	AMPS BATT.
F18	30A	BCM 1 BATT.
F19	10A	MIRROR BATT.
F20	25A	W/W FR LH BATT.
F21	5A	STARTER RELAY COIL
F22	5A	BCMIGN
F23	5A	IGN RELAY COIL
F24	5A	W/W IGN.
F25	5A	IMMOIGN.
F25A	5A	AT IGN
F26	10A	EMS IGN.
F27	10A	ABS/ESP BK PEDAL SW IGN.

F28	10A	INSTRUMENT CLUSTER IGN
F29	5A	SRS IGN.
F30	15A	STOP/REV LAMP
F31	10A	TOD FR AXLE IGN.
F32	5A	PDC,INT WIPE
F33	10A	WATER SEDIMENT VEH SPEED IGN
F34	10A	FR HVAC IGN.
F35	25A	FR,RR WIPER IGN.
F36	5A	REAR BLOWER SW IGN.
F37	5A	MIRROR SET / FOLD
F38	5A	INFOTAINMENT IGN.
F39	10A	REAR FOG LAMP IGN.
F40	5A/15A	AMMS ACC / TOW BAR IGN.
F41	15A	POWER SOCKET III ACC
F42	15A	CIGAR LIGHTER I, II
F43	30A	REAR BLOWER ACC
F44	5A	HRS COIL ACC
F45	5A	ACC RELAY COIL
R0	-	AT REV. LAMP RELAY
R1	-	MIRROR SET RELAY
R2	-	MIRROR FOLD RELAY
R3	-	POWER MIRROR FOLD RELAY
R4	-	IGN RELAY
R5	-	6-WAY DIODE MODULE
R6	-	INTERIOR LAMP RELAY
R7	-	CENTRAL DOOR LOCKING RELAY-3
R8	-	CENTRAL DOOR LOCKING RELAY-1
R9	-	REAR FOG LAMP RELAY
R10	-	PARK LAMP RELAY
R11	-	CENTRL DOOR LOCKING RELAY-2

BULB SPECIFICATION :

SR.NO	DESCRIPTION	CAP TYPE	SPECIFICATION	QUANTITY
1	Head Lamp - High Beam		H7 12 V 55W	2
2	Head Lamp - Low Beam		H7 12 V 55W	2
3	Head Lamp - Turn Indicator	PY24W	12V 24W	2
4	Head Lamp - Position Lamp	W5W	12 V 5W	2
5	Tail Lamp - Stop/Tail	P 21 / 5W	12 V 21/5W	2
6	Tail Lamp - Turn Indicator	P 21 W	12 V 21W	2
7	Tail Lamp - Rear Fog	P 21 W	12 V 21W	2
8	Tail Lamp - Reverse	P 21 W	12 V 21W	2
9	High Mounted - Stop Lamp		LED	1
10	Registration Plate Lamp	W5W	12 V 5W	2
11	Door Ajar cum Puddle Lamp	W5W	12 V 5W	4
12	Roof Lamp - Third	W5W	12 V 5W	3
13	Roof Lamp - First & Second	W5W	12 V 5W	6
14	Load Area Lamp	W5W	12 V 5W	1
15	Front Fog Lamp		H11 12 V 55W	2
16	Side Repeater Lamp		LED	2
17	Glove Box Lamp	W 5 W	12V 5W	1

Head lamp bulb replacement :

Procedure:

CAUTION

- Bulbs can be very hot. You should therefore allow them to cool down before you change them.
- Keep bulbs out of reach of children.
- Never use a bulb which has been dropped. Such a bulb may explode and injure you.
- Do not touch or handle bulbs with bare hand

Before you change the bulb :

- Only fit bulbs of the same type and wattage.
- Switch the lights OFF before changing a bulb to prevent short circuit.
- Always hold the bulb with a clean, lint free cloth.
- Do not work with wet or greasy fingers.
- If the new bulb does not come ON, contact the nearest Tata authorized service centre.

- Handle the bulb only at metal part and not at glass portion.

Removal procedure:

1. Open the bonnet.
2. Remove the socket cover on the backside of the headlamp.



NOTE

Both the bulbs can be replaced by the procedure described below.

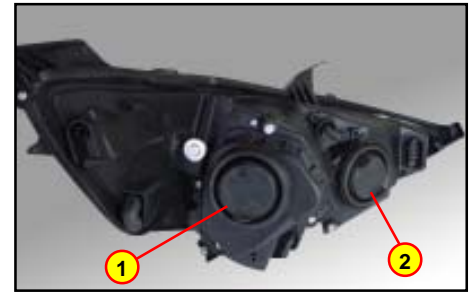

1. Low beam bulb cover
2. High beam bulb cover

3. Disconnect the connector by pulling it out firmly.



4. Release the bulb retainer spring which is holding the bulb by pressing and moving it upward.



5. Remove the defective headlamp bulb carefully.



Fitment procedure:

1. Place the bulb properly by matching the rectangular notch in the bulb housing and the bulb seat.
2. Lock the headlamp bulb in place, by using the retainer spring. Confirm if the bulb is seated properly by looking through the front lens in case of high beam only.
3. Fix the connector.
4. Put back the socket cover.

Tail Lamp bulb replacement procedure:

CAUTION

- Allow bulbs to cool down before you change them.
- Keep bulbs out of reach of children.
- Never use a bulb which has been dropped. Such a bulb may explode and injure you.

1. Open the tail gate
2. Remove the two nuts holding the tail lamp.



3. Disconnect the connector by pulling it out firmly.

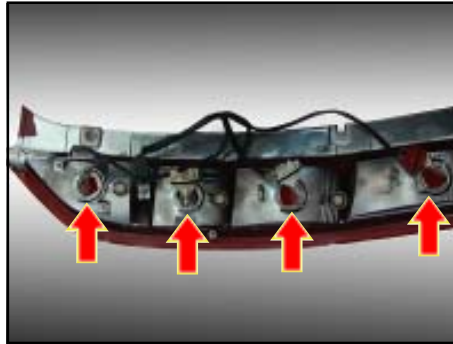

TAIL LAMP BULB REPLACEMENT

4. You can now replace any of the damaged / fused lamp bulbs from the tail lamp cluster.
5. Rotate the bulb holder in anticlockwise direction and remove the assy.
6. Take out the bulb from holder & replace with new one.
7. Rotate the bulb holder in clockwise direction for fitment.
8. Fit the tail lamp by fastening the nuts holding it.

NOTE

Same procedure is applicable for all the bulbs of tail lamp.

ENGINE COMPARTMENT

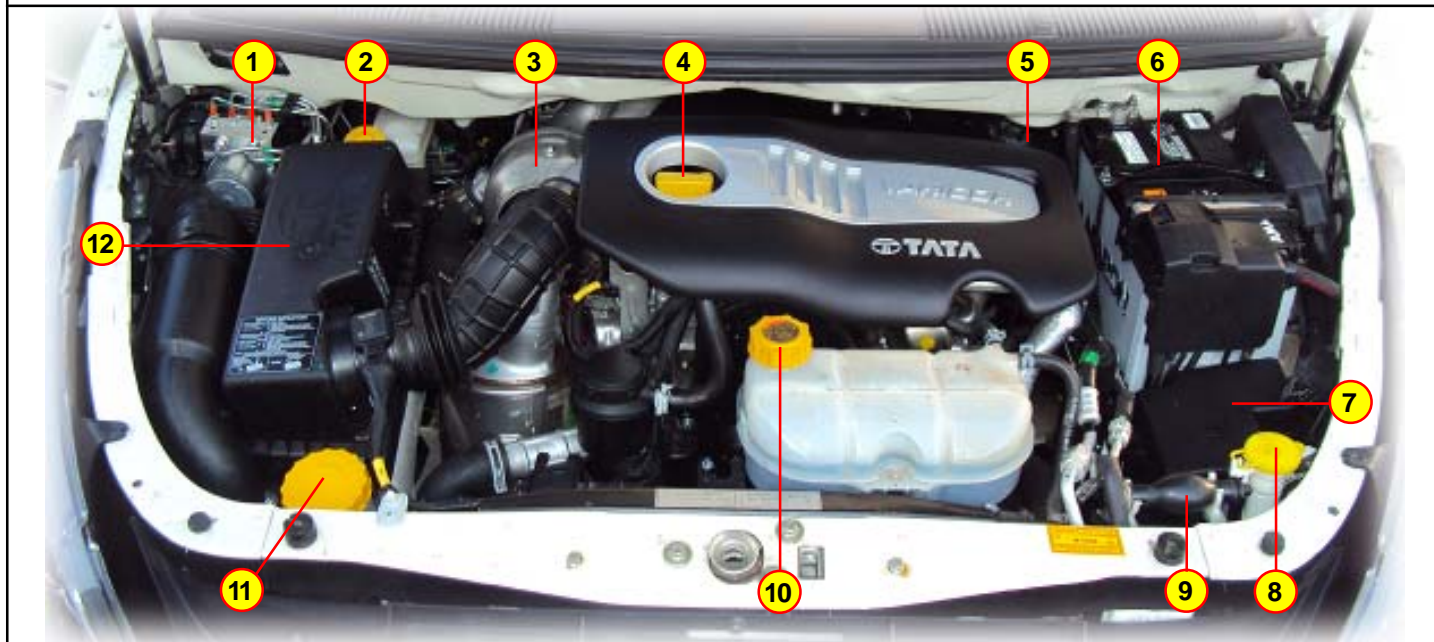

01. ABS/ESPECU/HCU	05. Engine Oil Dip Stick	09. Priming Pump
02. Brake / Clutch Fluid Reservoir	06. Battery	10. Auxiliary Tank
03. Turbocharger with heat shield	07. Fuse & Relay Box	11. Power Steering Fluid Container
04. Engine Oil Filling Cap	08. Windshield Washer Fluid Container	12. Air Filter

Air Filter:

Replace the air filter element with a new one when air filter gets too clogged . This is necessary if the vehicle is driven in dusty conditions.

Always use a genuine air filter element.

NOTE

1. When a vehicle is driven under dusty conditions, replacement of the air-cleaner element is necessary.
2. Clogged air-cleaners lead to increased resistance to air intake which increases fuel consumption. Using low pressure compressed air, blow off dust on the air cleaner element.

Engine oil level checking:

Warm up the engine to normal operating temperature.

Turn it off and wait for at least 30 minutes for the oil to return to the oil pan.

Be sure the vehicle is on a level surface.

Pull out the dipstick, wipe it clean, and reinsert if fully.

Pull it out again and examine the oil level. it should be between 'Min' and 'Max' level. If not, top up with recommended engine oil.

Engine coolant level:

Check the coolant level in the radiator auxiliary tank.

It should be in between maximum and minimum lines.

If the auxiliary tank is completely empty, please check the coolant level.

NOTE

If auxiliary tank is empty, fill it up to the 'MAX' level.



CAUTION

Do not open auxiliary tank cap in hot condition

Brake / Clutch Fluid Level :

The level of the brake / clutch fluid must be between the MIN. and MAX. marks on the side of the brake fluid container. If the level falls below the min. mark, add recommended brake fluid. (Refer section - Fuels, coolants and lubricants)

In case of spongy or hard pedal or low brake efficiency, please contact the nearest TATA authorised Service outlet.

⚠ CAUTION

1. Do not allow brake fluid to make contact with the skin or eyes. In case of accidental contact, wash eyes with cool water immediately and consult a doctor.
2. Do not allow brake fluid to splash or spill on the paint surface as it will damage the paint. In case of spillage, wipe it off immediately.

Power steering reservoir :

The level of the power steering fluid must be between the MIN. and MAX. marks on the side of the power steering fluid container. If the level falls below the MIN. mark, add recommended fluid. (Refer section - Fuels, coolants and lubricants)

In case of leakage or hard steering, please contact the nearest Authorised Service outlet.

⚠ CAUTION

1. Do not start the engine without oil in the power steering system.
2. Do not allow dirt into power steering fluid reservoir during refilling or top up.

Windshield Washer:

Windshield washer fluid container filler neck is provided near LH headlamp in the engine compartment.

NOTE

Do not add detergent or any solvent in the windshield washing water.

Fuel Filter:

Fuel filter separates dust particles from the fuel and allows clean fuel in to the fuel injection system. It also separates and stores water.

Get it replaced with genuine fuel filter and at specified intervals.

Turbocharger:

Your vehicle is fitted with a turbocharger. This is an efficient supercharging device used in the engine. It makes use of thermal energy of engine exhaust gases to run a turbine which in turn drives a compressor to force air under pressure into the inlet manifold.

Lubrication of Turbocharger:

The turbocharger rotor assembly is supported by two fully floating bearing bushes in the bearing housing. These bearing bushes are lubricated with finely filtered engine oil from the lubrication system of the engine.

Idle the engine for a while (one minute) after starting the engine and before stopping the engine to ensure adequate lubricating oil supply to the turbocharger.

Turbocharger Connections:

All turbocharger connections must be leak-proof. Check air inlet, air outlet, exhaust gas inlet and exhaust outlet connections as well as oil inlet and outlet

connections and tighten the connections where required.

Proper maintenance of air filter, oil filter as well as use of correct grade of oil and adherence to oil change intervals is essential for proper functioning of the turbocharger.

If you suspect any malfunctioning of the turbocharger, take the vehicle to the nearest dealer.

NOTE

Keep engine at idling speed for atleast a minute after starting and also before stopping, to protect the turbocharger against damage due to oil starvation.

Intercooler :

Hot air coming out of turbocharger flows through the intercooler and gets cooled before entering the intake manifold.

As such it does not require any maintenance however it can be cleaned externally by blowing compressed air.

CAUTION

While cleaning, ensure that intercooler fins are not damaged. If the fins get damaged, it could lead to lose of performance and subsequent failure.

Maintenance recommendations:

- Check the boost pressure pipe for its proper fitment, damage etc.
- Specified engine oil and the oil filter should be used and should be changed regularly in accordance with Service Schedule.
- Check oil feed pipes, return pipes, air intake and exhaust piping for leakages and restrictions.
- Check the engine breathing system and oil separator.
- Fill the oil inlet hole of the turbocharger with clean engine oil, when the engine is started after long storage.

NOTE

In cold condition, first 2 sec. engine should not run up to full throttle.

Catalytic Converter :

The catalytic converter is fitted on your car to reduce exhaust pollution. The catalytic converter will quickly heat up after starting to ensure that it operates correctly during the warm up phase of the engine.

The catalytic Converter does not require any special maintenance however, following precaution should be taken for the effective functioning of the converter and to avoid damage to the Converter.

- 1 It is mandatory to use Diesel fuel with low sulphur content (Refer recommended fuels). Use of any other diesel fuel can increase the pollutants.
- 2 Avoid parking the vehicle over inflammable materials, such as dry leaves, grass, etc., as the exhaust system is hot enough to initiate "FIRE".

Maintenance of Catalytic Converter

Catalytic Converter should be flushed by giving full throttle (4 to 5 times) in standing condition of vehicle on daily basis. For high speed driving condition run hot for few km as this will help to flush the carbon soot deposits from exhaust system and catalytic converter. High speed running of the vehicle may be done periodically to avoid chocking of catalytic converter.

Alternatively flushing operation for cleaning the catalytic converter can be done by dry compressed air draft (3 to 4 bar) directed on the honeycomb structure of catalytic converter (after removing from vehicle)

 CAUTION

- Avoid push start or tow-starting the vehicle. (Use jump leads).
- Avoid long (not more than 10 sec.) repeat (not more than 3 times) starting of the Vehicle. Investigate the cause for difficulty in starting & rectify the same.
- Avoid long idling (to warm-up). If the engine is running rough, after a cold start.
- Avoid switching "off" the ignition when driving down the hill. (This will not save fuel).
- Avoid fuel tank getting almost empty.
- Avoid pre-Coating / Painting of Catalytic Converter.

Tyres:

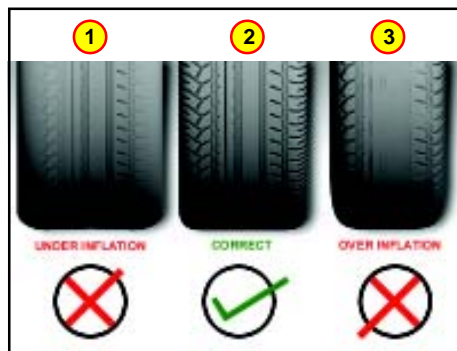

1.	Under inflation	Excessive Side Tread Wear
2.	Correct Tyre Pressure	Uniform Tyre Wear
3.	Over inflation	Excessive Centre Tread Wear

Recommended Tyre Pressures

Wheels	Unladen	Laden
FRONT	32 psi	34 psi
REAR	32 psi	34 psi

Check for inflation and condition of your car tyres periodically.

Inflation:

Check the pressure in the tyres when they are cold.

You should have your own tyre pressure gauge and use it at all times. This makes it easier for you to tell if pressure loss is caused by a tyre problem and not by variation between gauges.

Keeping the tyres properly inflated gives you the best combination of riding comfort, handling, tyre life and better fuel efficiency.

Over inflation of tyres makes the car ride bumpy and harsh. Tyres are more prone to uneven wear and damage from road hazards.

Under inflated tyres reduce your comfort in vehicle handling and are prone to failures due to high temperature. They also cause uneven wear and more fuel consumption.

⚠ CAUTION

Every time you check inflation pressure, you should also examine tyres for damage, trapping of foreign objects in the treads and wear.

NOTE

Tyre pressure should be checked in "cold" condition. Hot tyres tend to show a slightly higher value. This is normal.

Some make tyres are to be used on the vehicle with same size / aspect ratio.

⚠ CAUTION

1. If you notice bumps or bulges in the tread or the side of the tyre, replace the tyre.
2. If there are cuts, splits or cracks in the side of the tyre, replace the tyre.
3. Replace tyre if excessive tread wear or non uniform tyre wear is noticed.

Repairing a Tyre:

Mark the tyre position suitably (if original colour dot mark is not visible) with respect to valve stem hole to ensure that the tyre is refitted in the original location on the wheel rim.

Ensure that balancing weights are not disturbed during removal of tyres.

Check the balance weight prior to the removal of the tyre. If found loose, mark its location on the rim and refit properly.

Balance the wheel after every dismantling and assembly of tyre on the wheel rim.

For Tyre Size and Rim Size , please refer Technical Information Chapter.

Special care for tubeless tyres :

1. While removing tyre from wheel rim and mounting it back on wheel rim, take precautions not to damage tyre bead. Use tyre removal and assembly machines. Damage or cut on tyre bead may cause gradual loss of air and deflation of tyre.
2. Do not scratch inside of tubeless tyre with metallic or sharp object. Tubeless tyres are coated with impermeable layer of rubber from inside which holds the air inside the tyre. Removal of this layer due to scratching may cause gradual loss of air and deflation.
3. If wheel rim gets damaged in service, get the wheel rim repaired/replaced immediately. Running the car with damaged rim may cause deflation of tyre and subsequent dislodging of tyre from rim.

4. Maintain recommended inflation pressure. Over-inflation, in particular, may cause puncture or bursting of tyre.

NOTE

Life and wear pattern of tyres depends on various parameters like tyre pressure, wheel alignment, wheel balancing, tyre rotation, etc. It also largely depends on vehicle speed, load carried, usage, driving habits, road conditions, tyre quality, etc. In case fault is suspected to be due to poor quality of tyres, the same may be taken up with concerned tyre manufacturer.

A sticker for tyre pressure values is fixed near door bottom hinge.

Tyre Rotation:

To help increase tyre life and distribute wear more evenly, you should have the tyres of your vehicle rotated at specific intervals or earlier depending on the operation of your vehicle.

The illustration below shows how to rotate tyres when normal spare wheel is included in tyre rotation.

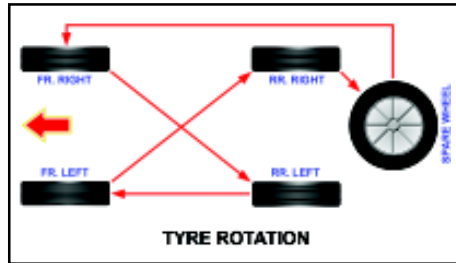

Wheel alignment:

Incorrect wheel alignment causes excessive and uneven tyre wear. Check wheel alignment at specified intervals. Wheel alignment values are given below:

	Front	Rear
Caster	$3^{\circ} \pm 30'$	-
Camber	$0^{\circ} \pm 30'$	-
Toe Out	-	-
Toe In	2 - 5 mm	-

Check and maintain tyre pressure periodically to obtain longer tyre life.

Wheel Balancing :

Wheels of your vehicle are balanced for better ride comfort and longer tyre life. Balancing needs to be done whenever tyre is removed from rim.

RADIAL TUBELESS TYRE :

Radial tubeless tyres have following advantages over conventional tube tyres:

- Lesser heat generation.
- Improves dynamic stability.
- Lower rolling resistance and lesser weight, which improves fuel efficiency.
- Better safety

Special care for tubeless tyres :

- Tubeless tyres are coated with impermeable layer of rubber from inside which holds the air inside the tyre. Do not scratch inside of tubeless tyre with metallic or sharp object. This may cause gradual loss of air.
- If wheel rim gets damaged in the service, get the wheel rim repaired/replaced immediately. Running the vehicle with damaged rim may cause deflation of tyre and subsequent dislodging of tyre from rim.
- Maintain recommended tyre pressure. Over inflated tyre may cause puncture or bursting of tyre.

NOTE

Life and wear pattern of tyres depends on various parameters like tyre pressure, wheel alignment, wheel balancing, tyre rotation, etc. It also largely depends on vehicle speed, load carried, usage, driving habits, road conditions, etc.

Battery :

Check the battery for proper electrolyte level and corrosion on the terminals.

1. Check the battery for electrolyte level against the marking on the battery outer case.
2. Check the battery terminals for corrosion (a white or yellowish powder). To remove it, cover the terminals with a solution of baking soda. It will bubble up and turn brown.
3. When this stops, wash it off with plain water. Dry off the battery with a cloth or paper towel.
4. Coat the terminals with petroleum jelly to prevent future corrosion.

Use a proper wrench to loosen and remove cables from the terminals.

Always disconnect the negative (-ve) cable first and reconnect it last.

Clean the battery terminals with a terminal cleaning tool or wire brush.

Reconnect and tighten the cables, coat the terminals with petroleum jelly.

Ensure that the battery securely mounted.

If you need to connect the battery to a charger, disconnect the battery negative cable to prevent damage to your vehicle's electrical system.

NOTE

- During normal operation, the battery generates gas which is explosive in nature. A spark or open flame can cause the battery to explode causing very serious injuries.
- Keep all sparks and open flames and smoking materials away from the battery.

- Getting electrolyte in your eyes or on the skin can cause severe burns. Wear protective clothing and a face shield or have a skilled technician to do the battery maintenance.
- The battery contains sulphuric acid (electrolyte) which is poisonous and highly corrosive in nature.

For location of Battery, please refer Engine compartment pages.

Window Glasses :

Cleaning of Windows, Front and Rear Glasses:

Clean the windows inside and outside with commercially available glass cleaners.

This will remove the haze that builds up on the inside of windows. Use a soft cloth or paper towels to clean all glass and plastic surfaces.

Non use maintenances :

1. Park the vehicle in covered, dry and if possible well-ventilated premises. Engage a gear.
2. Remove the battery terminal cables (first remove the cable from the negative terminal).
3. Make sure the hand brake is not engaged.
4. Clean and protect the painted parts using protective wax.

5. Clean and protect the shiny metal parts using commercially available special compounds.
6. Sprinkle talcum powder on the rubber windscreen wiper and lift them off the glass.
7. Slightly open the windows.
8. Cover the Car with a cloth or perforated plastic sheet. Do not use sheets of imperforated plastic as they do not allow moisture on the vehicle body to evaporate.
9. Inflate the tyres to 0.5 bar above the normal specified pressure and check it at regular intervals.
10. Check the battery charge every six weeks.
11. Do not drain the engine cooling system.

Wiper Care :

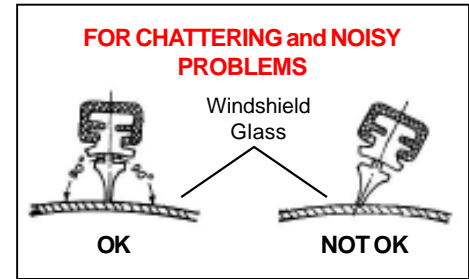

Wiper blade attack angle on windshield glass should be 90° i.e. perpendicular.

Remove wiper blade and root wiper arm on windshield glass in the centre position. Check the gap between arm strip and glass.

VEHICLE CARE :

Your vehicle is subjected to many external influences such as climate, road conditions, industrial pollution and humidity. These conditions demand regular care of the Car body. Dirt, insects, bird droppings, oil, grease, fuel and stone chippings should be removed as soon as possible.

WASHING YOUR VEHICLE:

Following t tips while washing your vehicle :

HAND WASH:

1. Always wash your vehicle in shade and where the surface is at room temperature.
2. Wash with mild car wash soap like 'Car Shampoo' and use a soft 100% cotton cloth to avoid scratches.
3. To avoid scratches, please wear soft gloves . Remove finger rings, nails, wrist watch while washing.

4. To remove stubborn stains and contaminants like tar, use turpentine or cleaners like 'Stain remover' which are safe for paint surfaces.
5. Avoid substances like petrol, diesel, kerosene, benzene or other solvents that cause damage to paint.
6. Dry your vehicle thoroughly to prevent any damp spots.
7. Rinse all surfaces thoroughly to prevent any traces of soap and other cleaners as this may lead to the formation of stains on the painted surface later.

NOTE

Do not direct high pressure washer fluid/ water jets at electrical devices engine and their connectors during washing. This is to prevent malfunction/ failure of electrical system due to water ingress.

WAXING :

Waxing and polishing is recommended to maintain the gloss and wet-look appearance of your paint finish.

1. Use a good quality polish and wax for your car.
2. Re-wax your vehicle when the water does not slip off the surface and collects over the surface in patches.

TIPS FOR THE CARE OF YOUR NEW VEHICLE FINISH :

If your vehicle is washed in an automatic car wash, please remember that the paint can be scratched by type of brushes, unfiltered washing water or the washing process itself. Scratching reduces paint durability and gloss, especially on darker colours. It is suggested to wash the car by hand with cool and clean water using a soft cloth or sponge. Please do not use soap but a car shampoo recommended by your dealer.

PRECAUTIONS:

1. Always wash your vehicle in shade, avoiding direct exposure to sunlight during washing.
2. Dry wiping your vehicle may lead to the formation of scratches. Always use a soft cloth and clean water while wiping your vehicle.
3. Always keep your vehicle parked in a well ventilated shade. Exposure to heat with entrapped moisture promotes corrosion.
4. Avoid driving on gravel roads, as the possibility of paint chip off due to the impact of stones is high. Also avoid driving on freshly tarred road.
5. External contamination in the form of sap or industrial fall-out may mar or develop spots on a new finish. Hence avoid parking your car near trees, which are known to drop sap, or near factories.
6. Bird droppings may damage the paint finish, hence bird dropping must be immediately washed off.

7. The paint finish is susceptible to damage in case petrol, brake fluid, liquid from vehicle battery, oil, antifreeze, transmission fluid or windshield solvent spills onto the painted surface. In case of such a spillage immediately rinse the affected area with water. Avoid wiping the area as far as possible. If wiping is required, wipe the area gently with soft cotton cloth.
8. Avoid using sharp objects to scrap off tar / mud from a painted surface.

VARIOUS ENVIRONMENTAL HAZARDS AFFECTING PAINTS:

The enemy :

Ultraviolet Rays, Pollution, Tree Sap, Bird Droppings, Car Wash Chemicals, Road Salt, Acid Rain.

Benefits of external enrichment :

- Removal of medium scratches, orange peel, oxidation, dust nibs etc and swirl marks from painted surface.

- Restoration of original gloss levels UV protection after gloss is restored.
- Cleaning and dressing of tyres, Bumpers and all exterior plastic moldings / trims.

CLEANING OF CARPETS:

Vacuum clean the carpet regularly to remove dirt. Dirt will make the carpet wear out faster. Periodically shampoo the carpet to keep it looking new.

Use carpet cleaners (preferably foam type). Follow the instructions that come with the cleaner. Apply it with a sponge or soft brush. Keep the carpeting as dry as possible by not adding water to the foam.

NOTE

Avoid wiping of painted surface in dry condition as it may leave scratches on the painted surface.

GENERAL PRECAUTIONS:

Fuel : High Speed diesel conforming to IS1460 or EN 590 or equivalent is recommended to be used as fuel.

At very low temperature, fluidity of diesel may become insufficient due to paraffin separation. It is therefore necessary to mix supplementary fuel with summer or winter grade diesel. The supplementary fuel to be used is kerosene or aviation turbine fuel.

Ratio for mixing of supplementary fuel and diesel are shown in the table.

Outside Ambient temp. upto Deg.C	Percentage	
	Summer Grade Diesel	Supplimentary Fuel
Upto 0°C	100	0
0°C to -10°C	70	30
-10°C to -15°C	50	50

Care should be taken that diesel and supplementary fuel are thoroughly mixed before filling.

Outside Ambient temp. upto Deg.C	Percentage	
	Winter Grade Diesel	Supplimentary Fuel
Upto -15°C	100	0
-15°C to -20°C	70	30
-20°C & Above	50	50

WARNING

Do not mix gasoline or alcohol with diesel. This mixture can cause explosion.

LUBRICANTS AND COOLANTS:

Lubricants:

Engine oil : Recommended grade of engine oil conforming to API-CH4+MB228.3 or higher grade engine oil to be used. Specification and range of ambient temperature at which these can be used are given in the table below :

Ambient temp. in deg.C	Engine oil grade
-5 and above	SAE 15W40
-10 to 0	SAE 5W30
-20 to -10	SAE 0W30

Gear box:

75W90 GL 4 Synthetic.

Brake / Clutch fluid :

SAE J 1703, DOT 4

Power Steering :

ATF - A Dexron II-D

Coolants

Presence of dirt in coolant chokes up passages in radiator, cylinder head and crankcase, thereby causing overheating of engine.

To prevent rust formation and freezing of coolant inside the passages of radiator, crankcase and cylinder head use premixed coolant as recommended.

It is recommended that the entire cooling system should be drained and filled with fresh premixed coolant.

Windscreen Washer Antifrost

Concentration - 1:5 For 0°C
 1:1 For 10°C
 2: 5 For 16°C
 1: 0 For 37°C

NOTE

We strongly recommend to refill your car's engine coolant only at a TATA Authorised service centre.

LUBRICANTS AND COOLANTS

ITEM	SPECIFICATION	COMPANY	BRAND	QUANTITY
ENGINE OIL	API-CH4+MB228.3 (15W40)	CASTROL HPCL EXXON MOBIL	GTX Professional Diesel Milcy No.1TGO Mobil Super 1000 TM	7.5 Litres
COOLANT	50:50 ratio premixed	S-CCL HPCL CASTROL	Golden Cruiser Premium 1400M Thanda Raja P TGO Radicool SFO Premix	Approx. 9 Litres
GEARBOX (G-76)	75W90 GL4 SYNTHETIC	CASTROL HPCL EXXON MOBIL	Castrol Syntro 75W90 GL4 HP GO XP 75W90 TGO MOBILUBE 1 SHC 75W90	2.2 Litres
TOD		SHELL	Spirax S3 ATF MD3	1.35 Litres
POWER STEERING OIL	ATF-DEXRON IID	CASTROL HPCL EXXON MOBIL	Castrol TOD ATF DEX II Mobil ATF 220	1.6 Litres
REAR AXLE (Limited Slip Differential)	85W140 API-GL5 Anglomol 6043	HPCL CASTROL	HP Gear Oil XP 85W140 T2 Extra Long Life Rear Axle Oil 85W140	1.68 Litres and 0.09 Litres (For friction modifier)
REAR AXLE (Standard Differential)	85W140 API-GL5 Anglomol 6043	HPCL CASTROL	HP Gear Oil XP 85W140 T2 Extra Long Life Rear Axle Oil 85W140	1.68 Litres
LIVE FRONT AXLE	85W140 API-GL5 Anglomol 6043	HPCL CASTROL	HP Gear Oil XP 85W140 T2 Extra Long Life Rear Axle Oil 85W140	1.50 Litres
BRAKE / CLUTCH FLUID	SAE J 1703, DOT 4	S-CCI CASTROL PETRONAS	Tata Genuine Brake Fluid DOT4 Universal Brake Fluid DOT 4 TUTELA TOP 4 TM	As Required
GREASE (Where Applicable)		HPCL CASTROL	Multipurpose Grease-2 Castrol AP2	As Required

ENGINE	
Model	TATA 2.2 L VARICOR
Type	Direct injection, Common rail, Turbocharged, Intercooled Diesel engine
No. Of Cylinders	4 inline
Bore / Stroke	85 mm x 96 mm
Capacity	2179 cc
Maximum Engine Output	110 kW (150 Ps) @ 4000 rpm as per CMVR / 115 - (9) 1996
Maximum Torque	320 Nm @ 1500 - 3000 rpm as per CMVR 115 - (9) 1996
Compression Ratio	16 : 1
Firing Order	1-3-4-2
Engine Oil Capacity	Max. 7.5 litres. / Min. 5.5 litres.
CLUTCH	
Type	Single plate dry friction diaphragm type
Outside diameter of clutch lining	260 mm
Friction Area	560 cm ² (Approx)

GEAR BOX		
Model	GBS-76-5/4.1, MK-II with overdrive	
Type	Synchromesh on all gears	
No. of gears	5 Forward & 1 Reverse	
Gear Ratios	For R/A Ratio 4.1	
	1st	4.1
	2nd	2.22
	3rd	1.37
	4th	1.00
	5th	0.73
	Rev.	4.22
TRANSFER CASE		
Type	Torque On Demand. Single Speed with 2H and Auto mode.	
REAR AXLE		
Type	4 X 4: ESP Versions without LSD ABS Version with LSD	
	4 X 2: ESP Version without LSD ABS Version with LSD	
Ratio	4.1	

FRONT AXLE	
For 4 X 4	1) Independently suspended with Axle Disconnect. 2) Axle Ratio 4.1
For 4 X 2	Independently suspended
STEERING	
Type	Rack and Pinion steering with power assistance. (Hydraulic)
Ratio	17.5:1
Steering Wheel	380 mm dia. with Low pivot Tilt mechanism for adjusting height & collapsible column
BRAKES	
Service Brake	Vacuum assisted independent hydraulic brakes on front & rear through tandem master cylinder. Vacuum pump camshaft driven
Front Brakes	Ventilated disc brakes with twin pot caliper Disc dia. 302 (4X4) / 298 (4X2) Disc thickness : 26
Rear Brake	Disc brake (Drum in Hat) with Single pot caliper

Anti-lock Braking System (ABS)	4 channel , 4 sensors (For ABS)
Electronic Stability Program (ESP)	4 Channel, 4 Sensors & Other Sensors
Parking Brake	Lever type, Console mounted, Cable operated mechanical linkage acting on Rear wheels through DIH.
FRAME	
Type	Ladder type cranked frame with Box section members and welded cross members
Depth	152 mm (Max)
Width	80 mm (Max)
SUSPENSION	
Front	Double wishbone type with coil springs over Shock Absorber.
Rear	Coil spring type 5 link rigid axle suspension
Shock Absorber	Hydraulic double acting telescopic at Front & Rear
Anti-roll Bar	At both front & rear

WHEELS & TYRES	
Tyres	1) PSR 235/70 R16 Passenger Radial Tubeless 2) PSR 235 / 65 R17 Passenger Radial Tubeless
Wheel Rims	1) 6.5J X 16 Stylised Wheel Rims 2) 7.5J X 17 Alloy Wheel Rims
No. of Wheels	Front : 2 Rear : 2 Spare :1
FUEL TANK	
Capacity	60 Litres
ELECTRICAL STSTEM	
System Voltage	12 Volts (-ve earth)
Alternator Capacity	155 amps
Battery	12 V, 75Ah 20 Hrs (Pure LX) 12 V, 80Ah 20 Hrs (Pleasure & Pride)
PERFORMANCE	
Max. Speed at rated GVW	4 X 4 : 170 kmph 4 X 2 : 170 kmph
Grade Restartability at rated GVW	4 X 4 : 24% @ 1000 rpm 4 X 2 : 23% @ 1000 rpm
Max. Gradeability at rated GVW	4 X 4 : 45% 4 X 2 : 44%

WEIGHTS (kg)				
		Pure LX	Pleasure	Pride
Gross Vehicle Weight- BS-IV (4X2)				
	4X2	2685	2730	2750
	Front	1176	1204	1218
	Rear	1509	1526	1532
Gross Vehicle Weight- BS-IV (4X4)				
	4X4	-	2830	2850
	Front	-	1295	1309
	Rear	-	1535	1541
Max. permissible RAW BS-IV(4X2)				
		1580	1580	1580
Max. permissible RAW BS-IV (4X4)				
		1580	1580	1580
Kerb weight BS-IV (4X2)				
	FAW	11099	1127	1178
	RAW	961	978	947
Kerb weight BS-IV (4X4)				
	FAW	-	1218	1234
	RAW	-	987	991

PASSENGER CAPACITY

Passenger Capacity	Front Seat : Driver + 1, Middle Seat : 3, Rear Seat : 2 (Front Facing)
---------------------------	---

LUGGAGE SPACE

Net inside loading space	~ 1000 mm wide x ~ 800 mm long (with 4 passengers + Driver)
---------------------------------	--

MAIN CHASSIS DIMENSION AS PER ISO:612 in MM

Wheel Base	2850
Track Front	1580
Track Rear	1550
Front Overhang	905
Rear Overhang	1025 Over rear bumper
Overall Length	4780 Over rear bumper
Maximum Width	1895 - With Cladding, 1860 - W/o Cladding
Overall Height	Unladen -1780 Unladen -1740
Min. Turning Circle dia	11.5 m
Min. Turning Clearance Circle dia	12.5 m
Ground Clearance	200 mm

VEHICLE DIMENSIONS

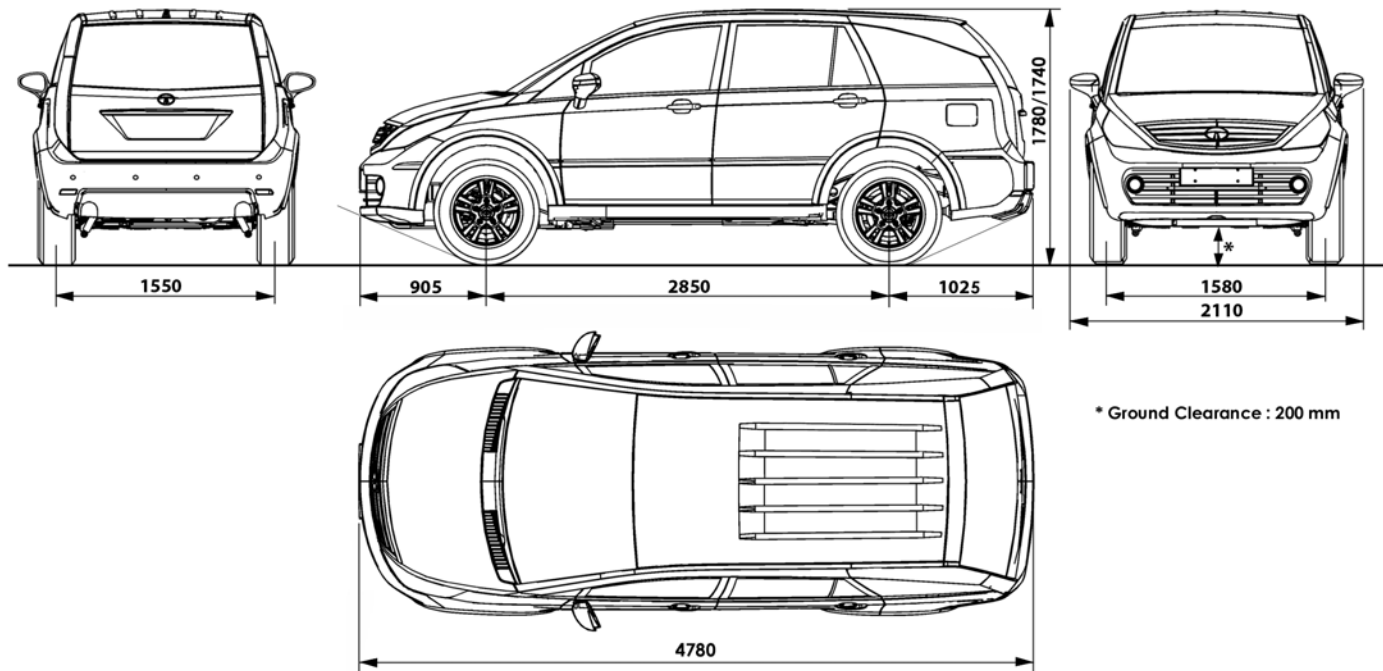

* Ground Clearance : 200 mm

(All dimensions are in mm and in unladen condition)



Chassis No. - Punched on RH Long member



VIN Number Plate (Near ABS Unit)



Engine Number Plate



Gear Box Number - Punched



TOD Number Plate



Rear Axle Number - Punched

SERVICE INSTRUCTIONS :

To achieve economical and trouble free performance, please follow the instructions as stated.

YOUR CAR IS ENTITLED TO FIVE FREE SERVICES (LABOUR ONLY). PLEASE PRESENT THESE COUPONS TO THE SERVICING DEALER WHILE AVAILING FREE SERVICES.

- 1st free service** - At 1000-1500 km. OR 1 month whichever is earlier
- 2nd free service** - At 4500-5500 km. OR 6 months whichever is earlier
- 3rd free service** - At 14500-15500 km. OR 12 months whichever is earlier
- 4th free service** - At 29500-30500 km. OR 24 months whichever is earlier

All services other than free services are chargeable.

Servicing of your vehicle can be done only at **TATA MOTORS** Authorised Dealership Workshop. The details of their locations are given in this manual.

Warranty claims can be settled by any **TATA MOTORS** Authorised Dealer for all failures, while all warranty claims excluding the consideration on the replacement of major aggregates, can be settled by any TASC which is authorised for handling warranty claims. TASCs will not handle warranty repairs.

SERVICE SCHEDULE

SL. NO.	OPERATION	FREQUENCY (in KM)	PDI	1000-1500	5000-5500	15000-15500	30000-30500	45000-45500	60000-60500	75000-75500	90000-90500	105000-105500
GENERAL												
1	Wash the vehicle & clean the condenser with compressed air.	Every Service	x	x	x	x	x	x	x	x	x	x
2	Check & Top up Fluids if required: Coolant, Brake / Clutch Fluid, Battery Electrolyte, Power Steering Oil, Gear Box Oil, Transfer Case & Front Axle (4X4)/ Rear Axle Oil	Every 15,000				x	x	x	x	x	x	x
3	Drain water accumulated in Fuel Pre filter cum sedimenter and fuel filter (OR whenever the Warning lamp glows)	Every Service	x	x	x	x	x	x	x	x	x	x
4	Check engine compartment for loose fasteners and for any leakages in fuel lines, coolant hoses, air hoses, vacuum hoses and hydraulic line connections. Attend if necessary.	Every Service	x	x	x	x	x	x	x	x	x	x
5	Check Underbody for loose fasteners & for any damage or leakage in fuel pipes, hydraulic line connections, rack & pinion & exhaust system including rubber hangers. Attend if necessary.	Every Service	x	x	x	x	x	x	x	x	x	x
6	Apply grease on door latches, locks, check straps, strikers, bonnet opening lever, bonnet hinges & lock plate, tailgate hinges & door lock inner ratchet.	Every Service			x	x	x	x	x	x	x	x
7	Check for proper tightening of Door latch & Striker screws, Tail gate latch and striker screws	Every Service			x	x	x	x	x	x	x	x
8	Check & ensure normal working of the vehicle using diagnostic equipment.	Every Service	x	x	x	x	x	x	x	x	x	x

SL. NO.	OPERATION	FREQUENCY (in KM)	PDI	1000-1500	5000-5500	15000-15500	30000-30500	45000-45500	60000-60500	75000-75500	90000-90500	105000-105500
2.2L VARICOR ENGINE												
1	*Change Engine Oil and Oil filter (Every 15,000 Km OR 1 year, whichever is earlier)	Every 15,000				x	x	x	x	x	x	x
2	Change Main Fuel filter (Every 30,000 Km OR 2 year, whichever is earlier)	Every 30,000					x		x		x	
3	Change element / carriage of Pre-filter cum Sedimentor (Every 15,000 Km OR 1 year, whichever is earlier)	Every 15,000				x	x	x	x	x	x	x
4	*Change Air filter element	Every 45,000						x			x	
5	Check accessory drive belts (Alternator & Compressor) Adjust tension, if requires, Change if damaged. (Every 15,000 Km OR 1 year, whichever is earlier)	Every 15,000				x	x	x	x	x	x	x
6	Inspect timing belt & if found damaged,replace along with tensioner									Every 1,20,000		
7	Change Timing Belt & Timing Belt tensioner									Every 1,50,000 OR 5 yrs whichever is earlier		
8	Change Engine Coolant (Every 60,000 km OR 2 year, whichever is earlier)	Every 60,000							x			
9	Check accessory drive belt for power steering pump, change if damaged (Every 15,000 Km OR 1 year, whichever is earlier)	Every 15,000				x	x	x	x	x	x	x
10	Change accessory drive belt for power steering pump.	Every 75,000								x		

SL. NO.	OPERATION	FREQUENCY (in KM)	PDI	1000-1500	5000-5500	15000-15500	30000-30500	45000-45500	60000-60500	75000-75500	90000-90500	105000-105500
GEAR BOX												
1	*Change Gear box Oil and Clean Breather	First at 45,000 & thereafter every 90,000						x				
2	Change Oil in TOD (For 4 X 4 Only)			Every 1,20,000								
PROPELLER SHAFT												
1	Grease propeller shaft with grease gun (at slip joint - splines end) & check Centre bracket mounting bolts for looseness. Tighten if necessary.	Every 15,000			x	x	x	x	x	x	x	x
2	Check for rubber cracks on Torsional Vibration Damper (TVD), replace if necessary	Every 15,000			x	x	x	x	x	x	x	x
3	Change TVD	Every 60,000							x			
FRONT AXLE (FOR 4X4) / REAR AXLE												
1	*Replace Axle Oil (Front (For 4x4) / Rear)	Every 75,000								x		
2	Clean Breather in front (FOR 4x4) and Rear axle	Every 15,000			x	x	x	x	x	x	x	x
SUSPENSION & STEERING												
1	Check wheel alignment/ / Steering wheel spoke alignment/ wheel balancing & adjust if necessary	Every 15,000			x	x	x	x	x	x	x	x
2	Check shock absorber, bushes replace if necessary	First at 30,000 & thereafter every service					x	x	x	x	x	x

SL. NO.	OPERATION	FREQUENCY (in KM)	PDI	1000-1500	5000-5500	15000-15500	30000-30500	45000-45500	60000-60500	75000-75500	90000-90500	105000-105500
3	Check condition of rubber bushes in Top & Lower wishbones, Anti roll bars, Rear links, Pan-hard rod, rubber boots/dust cover/ bellow in Rack & pinion, steering ball joints & column. Replace if necessary.	Every 30,000					x		x		x	
4	Replace Power steering Oil & filter element	Every 1,05,000										x
5	Change Power Steering Belt	Every 75,000								x		
BRAKES & CLUTCH												
1	Check parking brakes, adjust if necessary	Every Service		x	x	x	x	x	x	x	x	x
2	Check front brake & rear brake pads, re-grease DIH liner resting points. Replace if necessary.	Every 15,000				x	x	x	x	x	x	x
3	Replace Brake & Clutch Fluid (Every 45,000 km Or 2 years whichever is earlier)	Every 45,000						x			x	
ELECTRICALS												
1	Check headlamp focusing & functioning of all electrical equipments.	Every 15,000				x	x	x	x	x	x	x
2	Check for looseness of + Ve Terminals on Alternator and Starter motor	Every 30,000					x		x		x	
HVAC												
1	Check HVAC System for satisfactory performance, attend if required.	Every Service	x	x	x	x	x	x	x	x	x	x
2	Check and Clean A.C Filter	Every 15,000				x	x	x	x	x	x	x
WHEEL & TYRES												
1	Tyre Rotation	Every 15,000				x	x	x	x	x	x	x

* Under severe driving conditions, additional maintenance is required. Please Refer to “Additional Maintenance Schedule under severe driving conditions”:

Precautions to be taken while cleaning engine compartment : It is recommended to use dry low pressure air. Do not use pressurised water.

ADDITIONAL MAINTENANCE SCHEDULE UNDER SEVERE DRIVING CONDITIONS :

- A Driving in conditions such as Patrolling, Taxi, Pickup Van, Vehicle Towing, with Trailer Towing
- B Driving on Dusty / Sandy roads
- C More than 50% (in terms of kms) driving in heavy city traffic
- D Frequently operating in mountainous area

SL NO	ITEM	INTERVAL	CONDITION			
			A	B	C	D
1.	Engine oil & oil filter	Change every 7500kms	•	•	•	•
2.	Air filter element	Change at every 22500 km OR 1.5 year whichever is earlier		•	•	
3.	Front (for 4x4) & rear axle oil change	Change first at 15000kms & thereafter at 45000 kms	•	•		•

Km. reading	Fuel filled	Fuel consumption	Remarks / complaints

Km. reading	Fuel filled	Fuel consumption	Remarks / complaints

CHASSIS NO.....

Recommended Service	Date	Odometer Reading	Repair Order No.	Servicing Dealer's Signature and Stamp
At km.				
PDI				
1,500				
5,000				
15,000				
30,000				
45,000				
60,000				
75,000				
90,000				
1,05,000				
1,20,000				
1,35,000				

CHASSIS NO.....

Recommended Service	Date	Odometer Reading	Repair Order No.	Servicing Dealer's Signature and Stamp
At km.				
1,50,000				
1,65,000				
1,80,000				
1,95,000				
2,10,000				
2,25,000				
2,40,000				
2,55,000				
2,70,000				
2,85,000				
3,00,000				

Chassis No.

Engine No.

Gear Box No.

At **5,000-5,500 km** OR **6 months** whichever is earlier

please bring your vehicle for this service

as per details given in the **SERVICE SCHEDULE**.

2

**FREE
LABOUR**

TATA MOTORS
WORK DONE TO MY SATISFACTION

Sign. of Customer

Speedo Reading Km. seal O.K. / Broken

R.O. No. Date

Dealer's / Authorised Service Centre's

Stamp & Signature

At the time of delivery of vehicle, please ensure that pre-delivery inspection has been carried out as per details given in the **SERVICE SCHEDULE**.

Chassis No.

Engine No.

Gear Box No.

PDI

**FREE
LABOUR**

TATA MOTORS
WORK DONE TO MY SATISFACTION

Sign. of Customer

Speedo Reading Km. seal O.K. / Broken

R.O. No. Date

Dealer's / Authorised Service Centre's

Stamp & Signature

Chassis No.

Engine No.

At **15,000-15,500 km** OR **12 months** whichever is earlier

please bring your vehicle for this service

as per details given in the **SERVICE SCHEDULE**.

3

**FREE
LABOUR**

TATA MOTORS
WORK DONE TO MY SATISFACTION

Sign. of Customer

Speedo Reading Km. seal O.K. / Broken

R.O. No. Date

Dealer's / Authorised Service Centre's

Stamp & Signature

Chassis No.

Engine No.

At **1,000-1,500 km** OR **1 month** whichever is earlier

please bring your vehicle for this service

as per details given in the **SERVICE SCHEDULE**.

1

**FREE
LABOUR**

TATA MOTORS
WORK DONE TO MY SATISFACTION

Sign. of Customer

Speedo Reading Km. seal O.K. / Broken

R.O. No. Date

Dealer's / Authorised Service Centre's

Stamp & Signature

Chassis No.

4

Engine No.

At **30,000-30,500 km** OR **24 months** whichever is earlier
please bring your vehicle for this service
as per details given in the **SERVICE SCHEDULE**.

**FREE
LABOUR**

TATA MOTORS
WORK DONE TO MY SATISFACTION

Sign. of Customer

Speedo Reading Km. seal O.K. / Broken

R.O. No. Date

Dealer's / Authorised Service Centre's

Stamp & Signature



TATA MOTORS | SERVICE

RESPONSIVE • RELIABLE • BEST VALUE



TATA MOTORS | SERVICE
RESPONSIVE



24x7

ON-ROAD ASSISTANCE
1800 209 7979



TATA MOTORS | SERVICE
RESPONSIVE



DOORSTEP SERVICE

MOBILE SERVICE



TATA MOTORS | SERVICE
RESPONSIVE



ONLINE SERVICE

APPOINTMENT
AT A CLICK



TATA MOTORS | SERVICE
RESPONSIVE



QUICK REPAIR

REPAIR IN MINUTES



TATA MOTORS | SERVICE
RESPONSIVE



SPEED-O-SERVICE

FASTER SERVICE
DELIVERY



TATA MOTORS | SERVICE
BEST VALUE



EXTENDED WARRANTY

UP TO 4 YEARS



TATA MOTORS | SERVICE
BEST VALUE



RAPID REPAIR

MINOR BODY REPAIRS



TATA MOTORS | SERVICE
BEST VALUE



ORIGINAL PARTS

UNMATCHED QUALITY



TATA MOTORS | SERVICE
BEST VALUE



VALUE CARE

MAINTENANCE PLANS



TATA MOTORS | SERVICE
RELIABLE



DIAGNOSTIC EXPERT

HIGH SKILLED TECHNICIAN



TATA MOTORS | SERVICE
RELIABLE



QUALITY SERVICE

SERVICE QUALITY
ASSURANCE

HORIZONEXT



2870 5840 99 01



Designed & Developed by :
Content Creation & Publication, Customer Support-PVBU